



Design Example Report

Title	<i>50 W Auxiliary / Standby Supply Using TOPSwitch™-JX TOP267EG</i>
Specification	90 VAC – 264 VAC (50 Hz) Input; 5 V, 10 A Output
Application	Auxiliary / Standby Supply for Laser Printer
Author	Applications Engineering Department
Document Number	DER-245
Date	July 9, 2012
Revision	1.2

Summary and Features

- Highly energy efficient
 - Full load efficiency >82.5% (115 / 230 VAC)
 - Efficiency >78% above 1% load
 - Average efficiency >82% (25%, 50%, 75%, 100% load points)
 - No-load input power <130 mW (<100 mW achievable)
 - Simplifies meeting ENERGY STAR 2.0, 80 Plus and EuP requirements
 - 725 V MOSFET rating allowed high turns ratio (VOR) and use of 40 V Schottky output diode
- Low cost, low component count and small PCB footprint solution
 - Performance met without synchronous output rectification
 - 132 kHz operation optimized core size and efficiency performance
 - Low-profile eSIP package
- Integrated Protection and Reliability Features
 - Line undervoltage lock out (UVLO)
 - Short circuit protected (via auto-restart)
 - Auto recovery output over current (OCP)
 - Accurate thermal shutdown with large hysteresis

PATENT INFORMATION

The products and applications illustrated herein (including transformer construction and circuits external to the products) may be covered by one or more U.S. and foreign patents, or potentially by pending U.S. and foreign patent applications assigned to Power Integrations. A complete list of Power Integrations' patents may be found at www.powerint.com. Power Integrations grants its customers a license under certain patent rights as set forth at <http://www.powerint.com/ip.htm>.

Power Integrations

5245 Hellyer Avenue, San Jose, CA 95138 USA.

Tel: +1 408 414 9200 Fax: +1 408 414 9201

www.powerint.com

Table of Contents

1	Introduction.....	4
2	Power Supply Specification	6
3	Schematic.....	7
4	Circuit Description	8
4.1	Input EMI Filtering	8
4.2	TOPSwitch-JX Primary.....	8
4.3	Output Rectification	8
4.4	Output Feedback.....	8
5	PCB Layout	9
6	Bill of Materials	10
7	Transformer Specification.....	11
7.1	Electrical Diagram	11
7.2	Electrical Specifications.....	11
7.3	Materials.....	11
7.4	Transformer Build Diagram	12
7.5	Transformer Construction.....	13
8	Transformer Design Spreadsheet.....	14
9	Performance Data	19
9.1	Full Load Efficiency	19
9.2	Active Mode Efficiency	20
9.3	Light Load Efficiency	21
9.4	DC-DC Efficiency at 380 VDC Input.....	22
9.4.1	Light Load Efficiency (380 VDC Input)	22
9.4.2	Active Mode Efficiency (380 VDC Input)	23
9.5	No-load Input Power.....	24
9.6	Available Standby Output Power	25
9.7	Regulation	26
9.7.1	Load	26
9.7.2	Line	27
10	Thermal Performance	28
11	Waveforms.....	29
11.1	Drain Voltage and Current, Normal Operation.....	29
11.2	Output Voltage Start-up Profile.....	30
11.3	Drain Voltage and Current Start-up Profile	32
11.4	Load Transient Response	33
11.5	Output Ripple Measurements.....	34
11.5.1	Ripple Measurement Technique	34
11.5.2	Measurement Results	35
12	Control Loop Measurements.....	36
12.1	115 VAC.....	36
12.2	230 VAC.....	36
13	Revision History	37



Important Note:

Although this board is designed to satisfy safety isolation requirements, the engineering prototype has not been agency approved. Therefore, all testing should be performed using an isolation transformer to provide the AC input to the prototype board.



1 Introduction

This document is an engineering report describing a 50 W power supply utilizing a TOP267EG. This power supply achieves >80% efficiency at 100 VAC 50Hz, full load output current of 10 A without employing secondary synchronous rectification.

The EMI section is not designed for a typical 50 W power supply. The EMI components were chosen to resemble the input stage of a 200 W power supply unit. This is done to simulate EMI stage losses for a typical 200 W PSU in which this flyback converter will be the standby / auxiliary section of a complete system PSU. A 10 ohm NTC is also employed to include the additional losses associated with any inrush limiting in the final system.

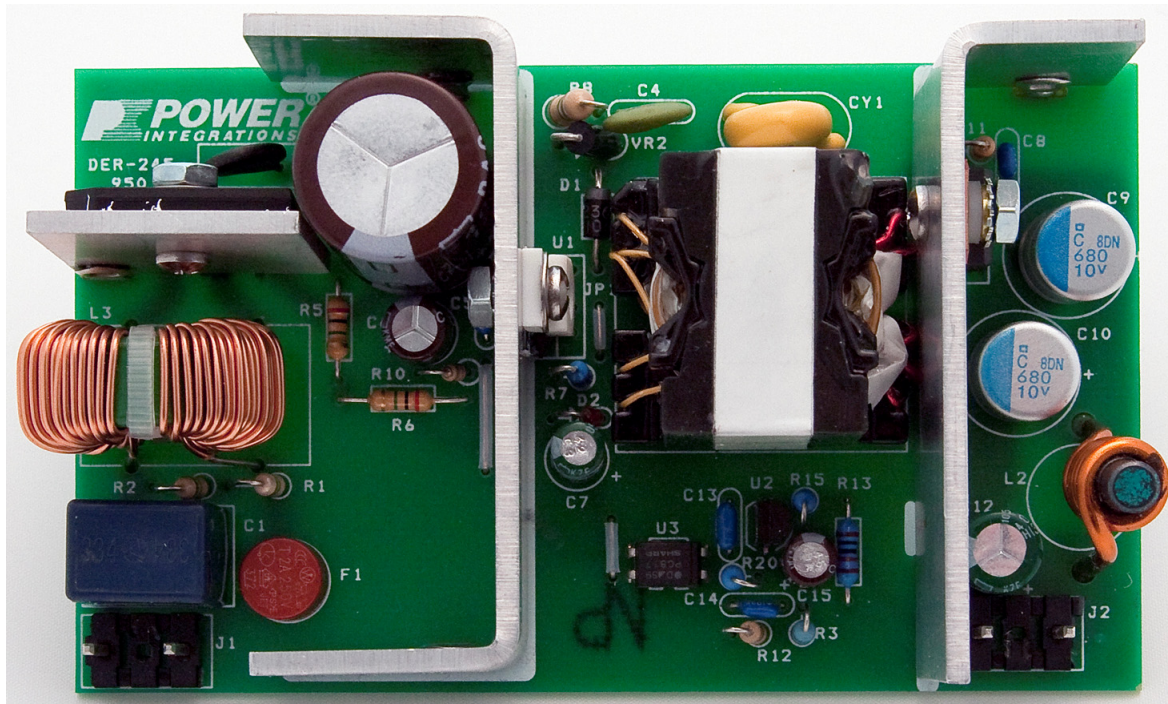

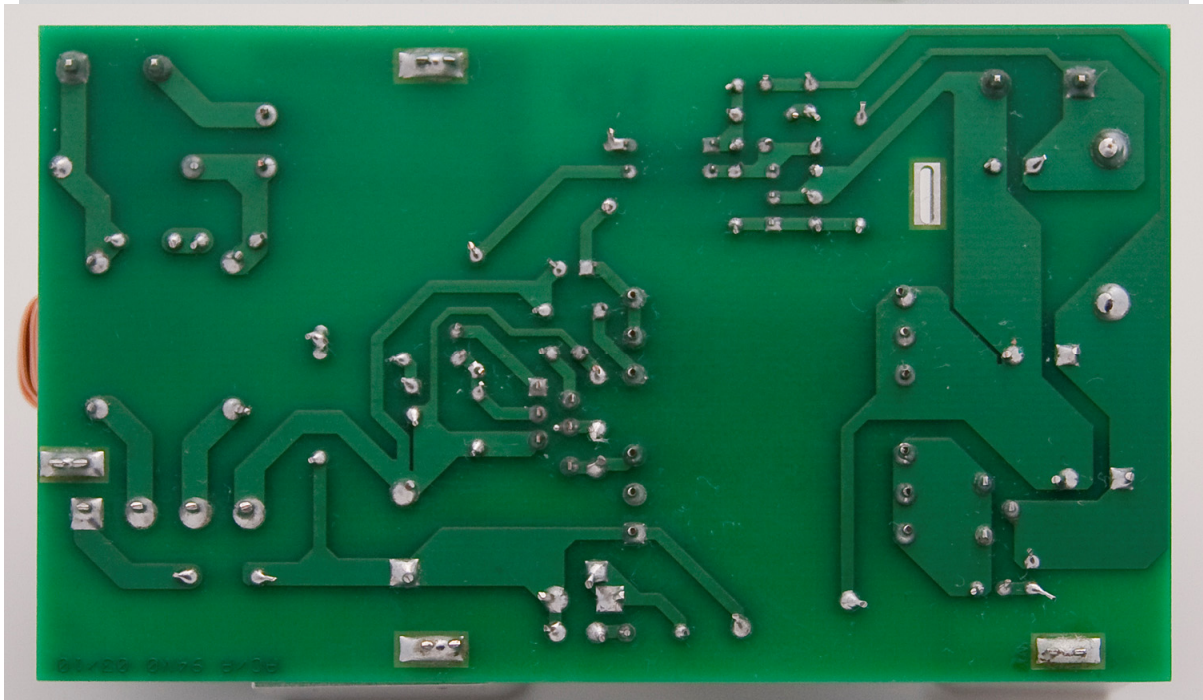
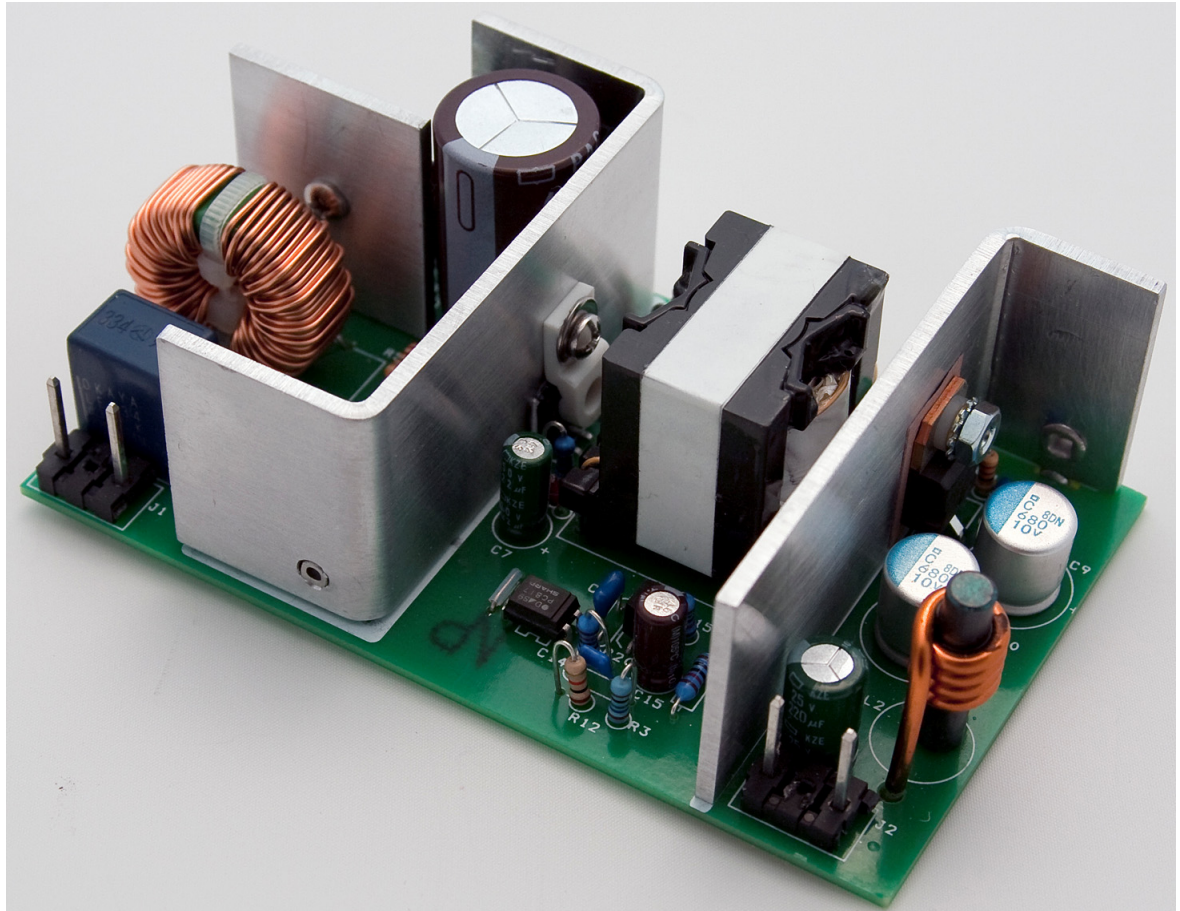

Figure 1 – Populated Circuit Board Photograph.



2 Power Supply Specification

The table below represents the minimum acceptable performance of the design. Actual performance is listed in the results section.

Description	Symbol	Min	Typ	Max	Units	Comment
Input						
AC Voltage	V_{IN}	90		264	VAC	2 Wire – no P.E.
Frequency	f_{LINE}		50		Hz	
DC	$V_{IN(DC)}$		380	390	VDC	
No-load Input Power (230 VAC)				0.3	W	
Output						
Output Voltage 1	V_{OUT1}		5		V	± 5% 20 MHz bandwidth
Output Ripple Voltage 1	$V_{RIPPLE1}$			200	mV	
Output Current 1	I_{OUT1}	0		10	A	
Total Output Power						
Continuous Output Power	P_{OUT}			50	W	
Efficiency						
Full Load	η	80			%	Measured at P_{OUT} 25 °C



3 Schematic

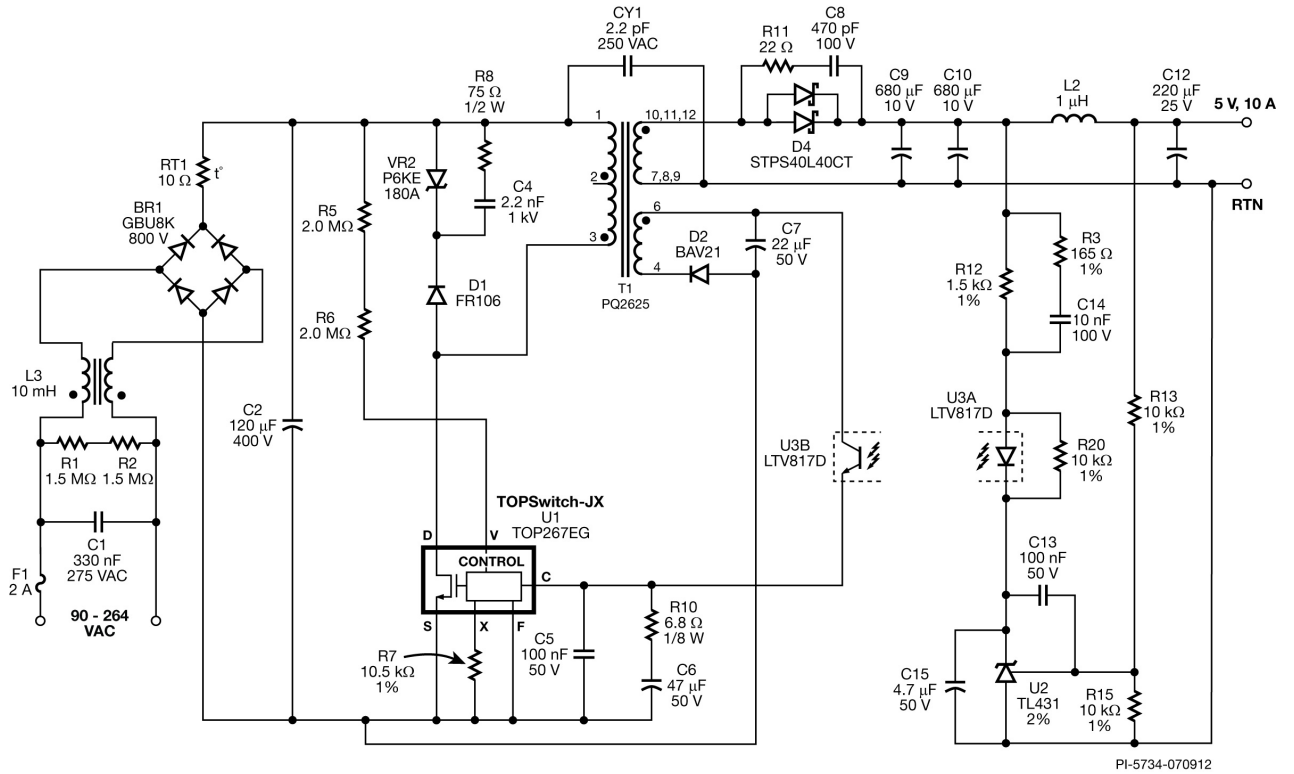

Figure 2 – Schematic Diagram.



4 Circuit Description

The circuit is built around a TOP267EG device from the TOPSwitch-JX family; a highly integrated monolithic off-line switcher IC designed for providing high-efficiency under all load conditions and very low no-load input power.

4.1 Input EMI Filtering

The EMI section of this unit consists of C1 (and associated discharge resistors R1 and R2) and L3. The filter stage was not designed and tested to meet conducted and radiated emissions standards. Instead it was included to represent the losses in the EMI filter for a 200 W output supply in which this 50 W design is the auxiliary / standby converter.

4.2 TOPSwitch-JX Primary

The TOP267EG is configured to operate at its full frequency mode (132 kHz) during heavy loading condition by shorting the F pin to the S pin. The 132 kHz operation reduces the maximum primary *rms* current by allowing more deeply continuous operation (lower value of K_P) and thus helps to improve efficiency by lowering conduction losses. Compared to operation at 66 kHz, this can be achieved without excessive transformer turns or a larger core size. At high input voltages (400 VDC), the converter operates in critically discontinuous conduction mode which reduces switching losses of the TOPSwitch-JX and the reverse recovery losses associated with the secondary rectifier. A 4 M ohm total resistance connected to the V pin enables the UV/OV feature of the IC. Resistor R7 is also connected between X pin and S pin to lower the current limit to 60% and prevents the transformer from saturating during start-up and short circuit conditions. The 10.5 k ohm resistor sets the peak flux density to < 3600 Gauss.

4.3 Output Rectification

The T1 output is rectified and filtered by D4, C9, and C10. Diode D4 is a low drop power Schottky rectifier with 40 V PIV rating. The transformer is designed to have lower secondary PIV to minimize secondary diode conduction losses. Capacitors C9 and C10 are high ripple current, ultra low *ESR* capacitors in a small package. Capacitors C9 and C10 were chosen to minimize board space requirement for the output capacitors and at the same time cater for the secondary ripple current. Post filter L2 and C12 provide high frequency output filtering.

4.4 Output Feedback

Resistors R13 and R15 are used to set the output voltage. Shunt regulator U2 drives optocoupler U3 through resistor R12 to provide feedback information to the U1 control pin. Components C13, C14, and R3 provide frequency compensation for the error amplifier U2.



5 PCB Layout

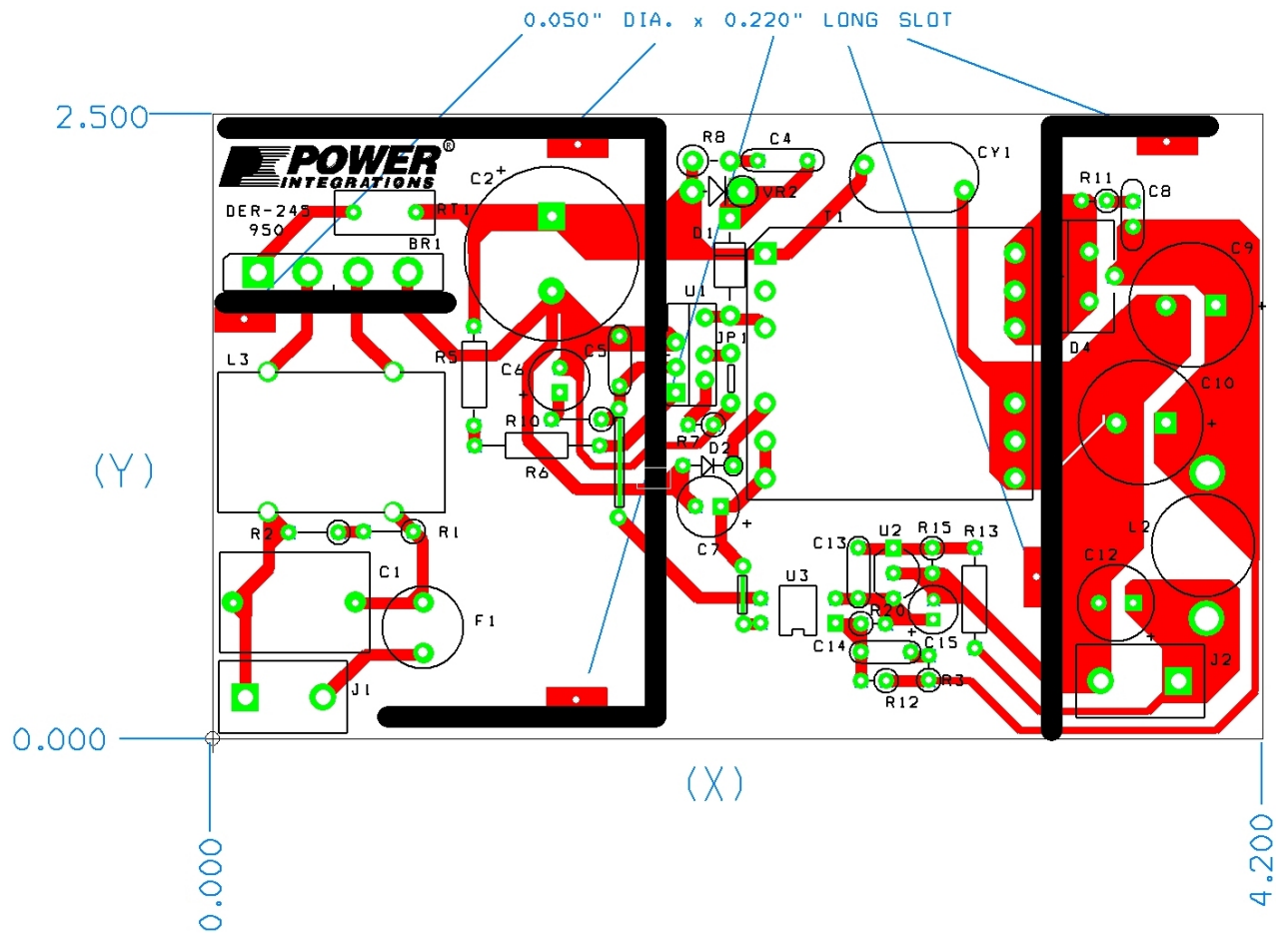

Figure 3 – Printed Circuit Layout (2.5 in x 4.2 in).



6 Bill of Materials

Item	Qty	Ref Des	Description	Mfg Part Number	Mfg
1	1	BR1	800 V, 8 A, Bridge Rectifier, GBU Case	GBU8K	Vishay
2	1	C1	330 nF, 275 VAC, Film, X2	LE334-M	OKAYA
3	1	C2	120 μ F, 400 V, Electrolytic, (18 x 30)	EPAG401ELL121MM30S	Nippon Chemi-Con
4	1	C4	2.2 nF, 1 kV, Disc Ceramic	NCD222K1KVY5FF	NIC Components
5	2	C5 C13	100 nF, 50 V, Ceramic, X7R	RPER71H104K2K1A03B	Murata
6	1	C6	47 μ F, 50 V, Electrolytic, Gen. Purpose, (6.3 x 11)	EKMG500ELL470MF11D	Nippon Chemi-Con
7	1	C7	22 μ F, 50 V, Electrolytic, Very Low ESR, 340 m Ω , (5 x 11)	EKZE500ELL220ME11D	Nippon Chemi-Con
8	1	C8	470 pF, 100 V, Ceramic, X7R	B37981M1471M000	Epcos
9	2	C9 C10	680 μ F, 10 V, Super Low ESR, 7 m Ω , (16 x 20)	APSC100ELL681MJB5S	Nippon Chemi-Con
10	1	C12	220 μ F, 25 V, Electrolytic, Very Low ESR, 72 m Ω , (8 x 11.5)	EKZE250ELL221MHB5D	Nippon Chemi-Con
11	1	C14	10 nF, 100 V, Ceramic, X7R	B37981M1103K000	Epcos
12	1	C15	4.7 μ F, 50 V, Electrolytic, Gen. Purpose, (5 x 11)	EKMG500ELL4R7ME11D	Nippon Chemi-Con
13	1	CY1	2.2 nF, Ceramic, Y1	440LD22-R	Vishay
14	1	D1	800 V, 1 A, Fast Recovery Diode, 500 ns, DO-41	FR106	Diodes Inc.
15	1	D2	250 V, 250 mA, Fast Switching, DO-35	BAV21	Vishay
16	1	D4	40 V, 40 A, Dual Schotkky, TO-220AB	STPS40L40CT	ST
17	1	F1	2 A, 250 V, Slow, TR5	3721200041	Wickman
18	2	J1 J2	2 Position (1 x 2) header, 0.312 pitch, Vertical	26-50-3039	Molex
19	1	JP1	Wire Jumper, Non insulated, 22 AWG, 0.2 in	298	Alpha
20	1	L2	1 μ H		
21	1	L3	Common Mode Choke Toroidal	P/N T22148-902S	Fontaine Tech
22	2	R1 R2	1.5 M Ω , 5%, 1/4 W, Carbon Film	CFR-25JB-1M5	Yageo
23	1	R3	165 Ω , 1%, 1/4 W, Metal Film	MFR-25FBF-165R	Yageo
24	2	R5 R6	2.0 M Ω , 5%, 1/4 W, Carbon Film	CFR-25JB-2M0	Yageo
25	1	R7	10.5 k Ω , 1%, 1/4 W, Metal Film	MFR-25FBF-10K5	Yageo
26	1	R8	75 Ω , 5%, 1/2 W, Carbon Film	CFR-50JB-75R	Yageo
27	1	R10	6.8 Ω , 5%, 1/8 W, Carbon Film	CFR-12JB-6R8	Yageo
28	1	R11	22 Ω , 5%, 1/4 W, Carbon Film	CFR-25JB-22R	Yageo
29	1	R12	1.5 k Ω , 1%, 1/4 W, Metal Film	MFR-25FBF-1K50	Yageo
30	3	R13 R15 R20	10 k Ω , 1%, 1/4 W, Metal Film	ERO-S2PHF1002	Panasonic
31	1	RT1	NTC Thermistor, 10 Ohms, 3.2 A	CL-110	Thermometrics
32	1	T1	Bobbin, PQ26/25, Vertical, 12 pins	BPQ26/25-1112CPFR	TDK
33	1	U1	TOPSwitch-JX, TOP267EG, eSIP-7C	TOP267EG	Power Integrations
34	1	U2	2.495 V Shunt Regulator IC, 2%, 0 to 70C, TO-92	TL431CLPG	On Semiconductor
35	1	U3	Optocoupler, 35 V, CTR 300-600%, 4-DIP	LTV-817D	Liteon
36	1	VR2	180 V, 5 W, 5%, TVS, DO204AC (DO-15)	P6KE180ARLG	On Semi



7 Transformer Specification

7.1 Electrical Diagram

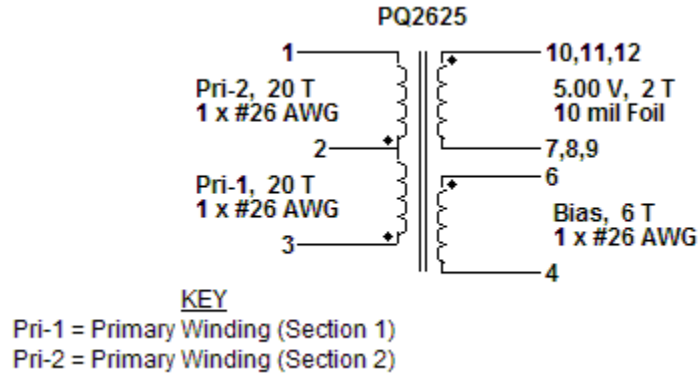

Figure 4 – Transformer Electrical Diagram.

7.2 Electrical Specifications

Electrical Strength	1 second, 60 Hz, from pins 1, 2, 3, 4, 6 to pins 7, 8, 9, 10, 11, 12	3000 VAC
Primary Inductance	Pins 1-3, all other windings open	653 μ H, \pm 10%
Primary Leakage Inductance	Pins 1-3, with all other windings shorted	10 μ H (Max.)

7.3 Materials

Item	Description
[1]	Core: PQ2625, NC-2H (Nicera) or equivalent, gapped for ALG of 406 nH/t ²
[2]	Bobbin: BPQ26/25-1112CPFR
[3]	Barrier tape: Polyester film (1 mil base thickness), 13.80 mm wide
[4]	Varnish
[5]	Triple Insulated Wire: #26 AWG
[6]	Copper Foil: 10 mil thick, 12.5 mm wide, covered with 1 layer of lapped tape. Terminations to foil: 4 x #19 AWG magnet wire with sleeving
[7]	#19 AWG magnet wire

7.4 Transformer Build Diagram

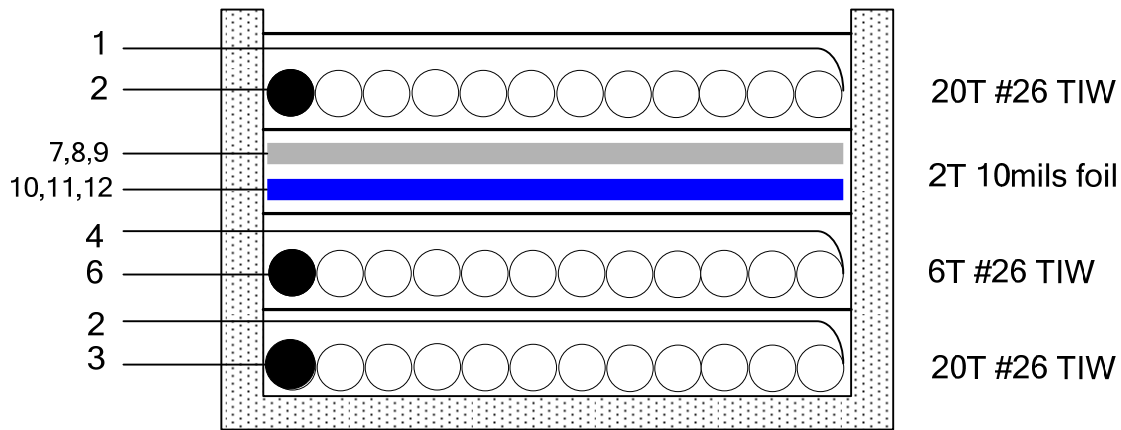

Figure 5 – Transformer Build Diagram.

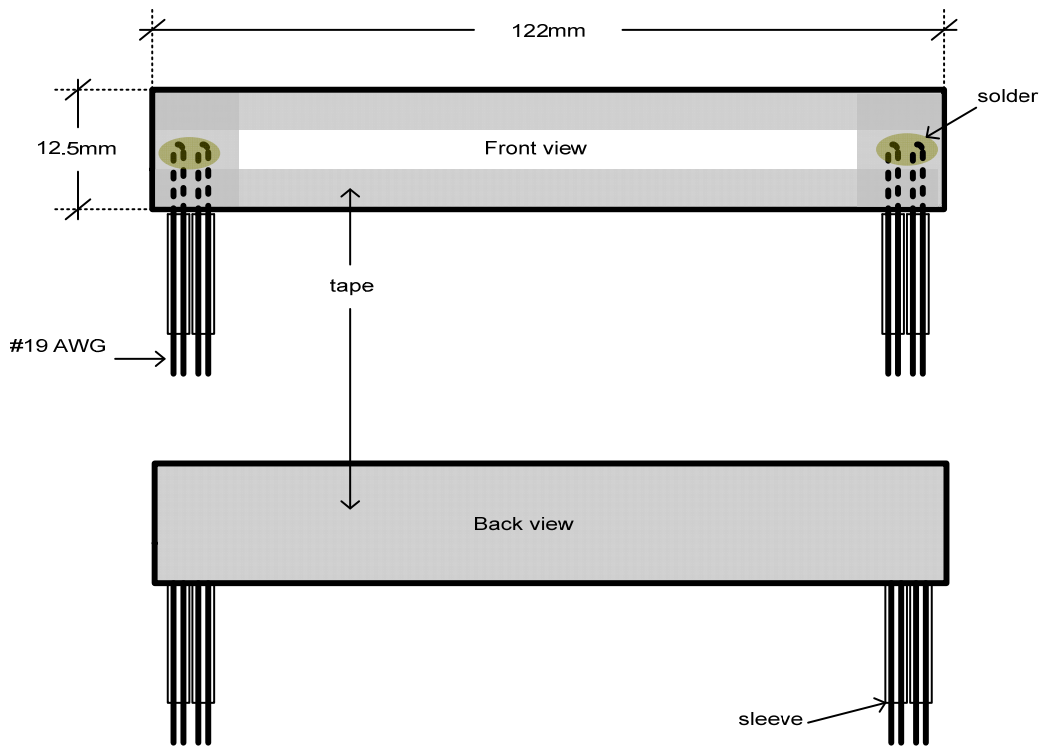

Figure 6 – Copper Foil Winding.

7.5 Transformer Construction

Primary Winding (Section 1)	Start on pin(s) 3 and wind 20 turns (x 1 filar) of item [5] in 1 layer(s) from left to right. Finish this winding on pin(s) 2. Add 1 layer of tape, item [3].
Bias Winding	Start on pin(s) 6 and wind 6 turns (x 1 filar) of item [5]. Wind in same rotational direction as primary winding. Spread the winding evenly across entire bobbin. Finish this winding on pin(s) 4. Add 1 layer of tape, item [3].
Secondary Winding	Start on pin(s) 10, 11, 12 and wind 2 turns of item [6]. Wind in same rotational direction as primary winding. Finish this winding on pin(s) 7, 8, 9. Add 1 layers of tape, item [3].
Primary Winding (Section 2)	Start on pin(s) 2 and wind 20 turns (x 1 filar) of item [5] in 1 layer(s) from left to right. Finish this winding on pin(s) 1. Add 1 layers of tape, item [3].
Core Assembly	Assemble and secure core halves. Item [1].
Varnish	Dip varnish uniformly in item [4]. Do not vacuum impregnate.



8 Transformer Design Spreadsheet

ACDC_TOPSwitchJX_120709; Rev.1.1; Copyright Power Integrations 2009	INPUT	INFO	OUTPUT	UNIT	TOP_JX_120709: TOPSwitch-JX Continuous/Discontinuous Flyback Transformer Design Spreadsheet
ENTER APPLICATION VARIABLES					
VACMIN	90			Volts	Minimum AC Input Voltage
VACMAX	264			Volts	Maximum AC Input Voltage
fL	50			Hertz	AC Mains Frequency
VO	5.00			Volts	Output Voltage (main)
PO_AVG	50.00			Watts	Average Output Power
PO_PEAK	50.00		50.00	Watts	Peak Output Power
Heatsink Type	External		External		Heatsink Type
Enclosure	Open Frame				Open Frame enclosure assume sufficient airflow while adapter means a sealed enclosure.
n	0.80			%/100	Efficiency Estimate
Z	0.48				Loss Allocation Factor
VB	15			Volts	Bias Voltage - Verify that VB is > 8 V at no load and VMAX
tC	3.00			ms	Bridge Rectifier Conduction Time Estimate
CIN	120.0		120	uFarads	Input Filter Capacitor
ENTER TOPSWITCH-JX VARIABLES					
TOPSwitch-JX	TOP267E			Universal / Peak	115 Doubled/230V
Chosen Device		TOP267E	Power Out	103 W / 103 W	137W
KI	0.68				External Ilimit reduction factor (KI=1.0 for default ILIMIT, KI <1.0 for lower ILIMIT)
ILIMITMIN_EXT			1.898	Amps	Use 1% resistor in setting external ILIMIT
ILIMITMAX_EXT			2.184	Amps	Use 1% resistor in setting external ILIMIT
Frequency (F)=132kHz, (H)=66kHz	F		F		Select 'H' for Half frequency - 66kHz, or 'F' for Full frequency - 132kHz
fS			132000	Hertz	TOPSwitch-JX Switching Frequency: Choose between 132 kHz and 66 kHz
fSmin			119000	Hertz	TOPSwitch-JX Minimum Switching Frequency
fSmax			145000	Hertz	TOPSwitch-JX Maximum Switching Frequency
High Line Operating Mode			FF		Full Frequency, Jitter enabled
VOR	110.00			Volts	Reflected Output Voltage
VDS			10	Volts	TOPSwitch on-state Drain to Source Voltage
VD	0.50			Volts	Output Winding Diode Forward Voltage Drop
VDB	0.70			Volts	Bias Winding Diode Forward Voltage Drop
KP	0.41				Ripple to Peak Current Ratio (0.3 < KRP < 1.0 : 1.0 < KDP < 6.0)
PROTECTION FEATURES					
LINE SENSING					V pin functionality



VUV_STARTUP	95.00		72	Volts	Minimum DC Bus Voltage at which the power supply will start-up
VOV_SHUTDOWN			356	Volts	Typical DC Bus Voltage at which power supply will shut-down (Max)
RLS			3.2	M-ohms	Use two standard, 1.6 M-Ohm, 5% resistors in series for line sense functionality.
OUTPUT OVERVOLTAGE					
VZ			27	Volts	Zener Diode rated voltage for Output Overvoltage shutdown protection
RZ			5.1	k-ohms	Output OVP resistor. For latching shutdown use 20 ohm resistor instead
OVERLOAD POWER LIMITING					
Overload Current Ratio at VMAX	1.20		1.2		X pin functionality Enter the desired margin to current limit at VMAX. A value of 1.2 indicates that the current limit should be 20% higher than peak primary current at VMAX
Overload Current Ratio at VMIN		<i>Info</i>	1.22		Your margin to current limit at low line is high. Reduce KI to 0.55 (if possible).
ILIMIT_EXT_VMIN			1.56	A	Peak primary Current at VMIN
ILIMIT_EXT_VMAX			1.03	A	Peak Primary Current at VMAX
RIL			9.36	k-ohms	Current limit/Power Limiting resistor.
RPL			N/A	M-ohms	Resistor not required. Use RIL resistor only
ENTER TRANSFORMER CORE/CONSTRUCTION VARIABLES					
Core Type	PQ2625		PQ2625		Core Type
Core		PQ2625		P/N:	PC44PQ26/25Z-12
Bobbin		PQ2625_BOBBIN		P/N:	*
AE			1.18	cm ²	Core Effective Cross Sectional Area
LE			5.55	cm	Core Effective Path Length
AL			5250	nH/T ²	Ungapped Core Effective Inductance
BW			13.8	mm	Bobbin Physical Winding Width
M	0.00			mm	Safety Margin Width (Half the Primary to Secondary Creepage Distance)
L	2.00				Number of Primary Layers
NS	2		2		Number of Secondary Turns
DC INPUT VOLTAGE PARAMETERS					
VMIN	85		85	Volts	Minimum DC Input Voltage
VMAX	400		400	Volts	Maximum DC Input Voltage
CURRENT WAVEFORM SHAPE PARAMETERS					
DMAX			0.59		Maximum Duty Cycle (calculated at PO_PEAK)
IAVG			0.74	Amps	Average Primary Current (calculated at average output power)
IP			1.56	Amps	Peak Primary Current (calculated at Peak output power)



IR			0.64	Amps	Primary Ripple Current (calculated at average output power)
IRMS			0.96	Amps	Primary RMS Current (calculated at average output power)
TRANSFORMER PRIMARY DESIGN PARAMETERS					
LP			656	uHenries	Primary Inductance
LP Tolerance			10		Tolerance of Primary Inductance
NP			40		Primary Winding Number of Turns
NB			6		Bias Winding Number of Turns
ALG			410	nH/T ²	Gapped Core Effective Inductance
BM			2163	Gauss	Maximum Flux Density at PO, VMIN (BM<3000)
BP			3340	Gauss	Peak Flux Density (BP<4200) at I _{LIMITMAX} and LP _{MAX} . Note: Recommended values for adapters and external power supplies <=3600 Gauss
BAC			443	Gauss	AC Flux Density for Core Loss Curves (0.5 X Peak to Peak)
ur			1965		Relative Permeability of Ungapped Core
LG			0.33	mm	Gap Length (Lg > 0.1 mm)
BWE			27.6	mm	Effective Bobbin Width
OD	0.48		0.48	mm	Maximum Primary Wire Diameter including insulation
INS			0.06	mm	Estimated Total Insulation Thickness (= 2 * film thickness)
DIA			0.42	mm	Bare conductor diameter
AWG			26	AWG	Primary Wire Gauge (Rounded to next smaller standard AWG value)
CM			256	Cmils	Bare conductor effective area in circular mils
CMA			266	Cmils/Amp	Primary Winding Current Capacity (200 < CMA < 500)
Primary Current Density (J)			7.52	Amps/mm ²	Primary Winding Current density (3.8 < J < 9.75)
TRANSFORMER SECONDARY DESIGN PARAMETERS (SINGLE OUTPUT EQUIVALENT)					
Lumped parameters					
ISP			31.11	Amps	Peak Secondary Current
ISRMS			15.92	Amps	Secondary RMS Current
IO_PEAK			10.00	Amps	Secondary Peak Output Current
IO			10.00	Amps	Average Power Supply Output Current
IRIPPLE			12.39	Amps	Output Capacitor RMS Ripple Current
CMS			3184	Cmils	Secondary Bare Conductor minimum circular mils
AWGS			15	AWG	Secondary Wire Gauge (Rounded up to next larger standard AWG value)
DIAS			1.45	mm	Secondary Minimum Bare



					Conductor Diameter
ODS			6.90	mm	Secondary Maximum Outside Diameter for Triple Insulated Wire
INSS			2.72	mm	Maximum Secondary Insulation Wall Thickness
VOLTAGE STRESS PARAMETERS					
VDRAIN			618	Volts	Maximum Drain Voltage Estimate (Includes Effect of Leakage Inductance)
PIVS			25	Volts	Output Rectifier Maximum Peak Inverse Voltage
PIVB			72	Volts	Bias Rectifier Maximum Peak Inverse Voltage
TRANSFORMER SECONDARY DESIGN PARAMETERS (MULTIPLE OUTPUTS)					
1st output					
VO1			5	Volts	Output Voltage
IO1_AVG			10.00	Amps	Average DC Output Current
PO1_AVG			50.00	Watts	Average Output Power
VD1			0.5	Volts	Output Diode Forward Voltage Drop
NS1			2.00		Output Winding Number of Turns
ISRMS1			15.921	Amps	Output Winding RMS Current
IRIPPLE1			12.39	Amps	Output Capacitor RMS Ripple Current
PIVS1			25	Volts	Output Rectifier Maximum Peak Inverse Voltage
CMS1			3184	Cmils	Output Winding Bare Conductor minimum circular mils
AWGS1			15	AWG	Wire Gauge (Rounded up to next larger standard AWG value)
DIAS1			1.45	mm	Minimum Bare Conductor Diameter
ODS1			6.90	mm	Maximum Outside Diameter for Triple Insulated Wire
2nd output					
VO2				Volts	Output Voltage
IO2_AVG				Amps	Average DC Output Current
PO2_AVG			0.00	Watts	Average Output Power
VD2			0.7	Volts	Output Diode Forward Voltage Drop
NS2			0.25		Output Winding Number of Turns
ISRMS2			0.000	Amps	Output Winding RMS Current
IRIPPLE2			0.00	Amps	Output Capacitor RMS Ripple Current
PIVS2			3	Volts	Output Rectifier Maximum Peak Inverse Voltage
CMS2			0	Cmils	Output Winding Bare Conductor minimum circular mils
AWGS2			N/A	AWG	Wire Gauge (Rounded up to next larger standard AWG value)
DIAS2			N/A	mm	Minimum Bare Conductor Diameter
ODS2			N/A	mm	Maximum Outside Diameter for Triple Insulated Wire
3rd output					
VO3				Volts	Output Voltage



IO3_AVG				Amps	Average DC Output Current
PO3_AVG			0.00	Watts	Average Output Power
VD3			0.70	Volts	Output Diode Forward Voltage Drop
NS3			0.25		Output Winding Number of Turns
ISRMS3			0.000	Amps	Output Winding RMS Current
IRIPPLE3			0.00	Amps	Output Capacitor RMS Ripple Current
PIVS3			3	Volts	Output Rectifier Maximum Peak Inverse Voltage
CMS3			0	Cmils	Output Winding Bare Conductor minimum circular mils
AWGS3			N/A	AWG	Wire Gauge (Rounded up to next larger standard AWG value)
DIAS3			N/A	mm	Minimum Bare Conductor Diameter
ODS3			N/A	mm	Maximum Outside Diameter for Triple Insulated Wire
Total Continuous Output Power			50	Watts	Total Continuous Output Power
Negative Output			N/A		If negative output exists enter Output number; eg: If VO2 is negative output, enter 2



9 Performance Data

All measurements performed at room temperature and 50 Hz input frequency for AC input.

9.1 Full Load Efficiency

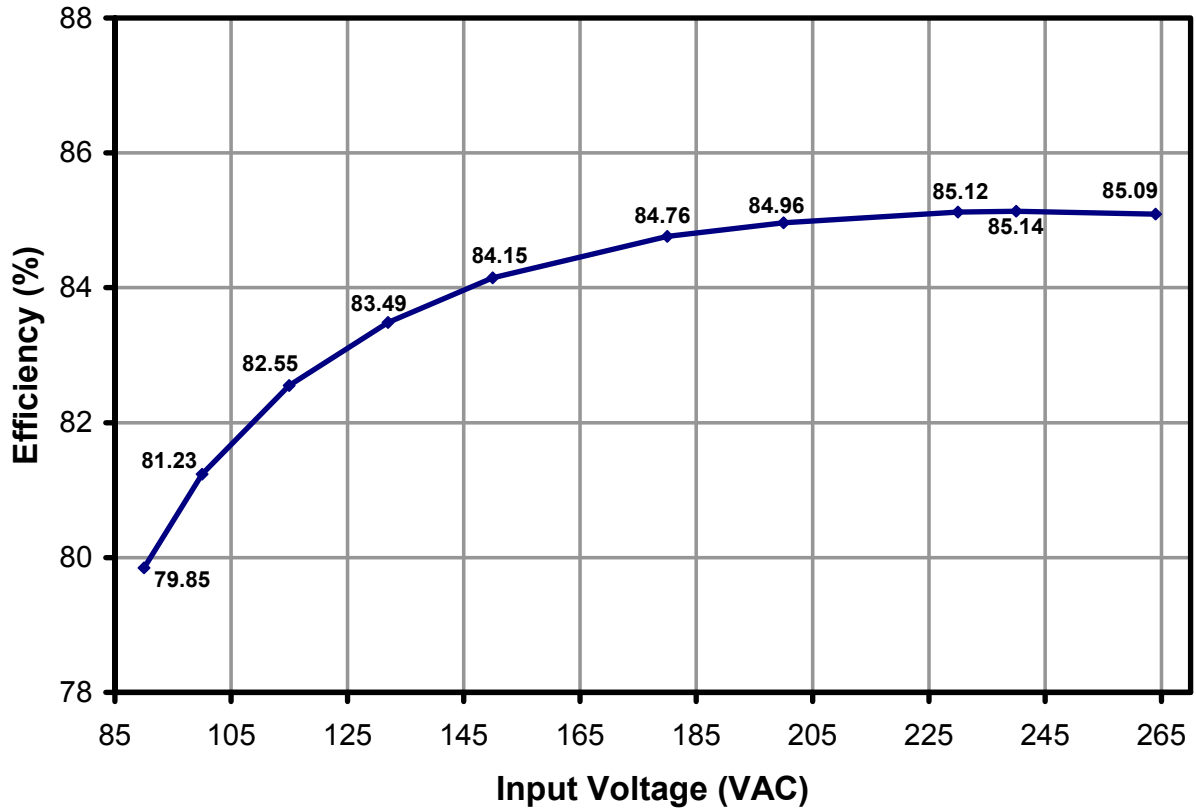

Figure 7 – Efficiency vs. Input Voltage, Room Temperature, 50 Hz.

Full Load Efficiency				
V_{IN} (VAC, 50 Hz)	P_{IN} (W)	V_{OUT} (V)	I_{OUT} (A)	Efficiency (%)
90	62.62	5.00	10	79.85
100	61.55	5.00	10	81.23
115	60.57	5.00	10	82.55
132	59.89	5.00	10	83.49
150	59.42	5.00	10	84.15
180	58.99	5.00	10	84.76
200	58.85	5.00	10	84.96
230	58.74	5.00	10	85.12
240	58.73	5.00	10	85.14
264	58.76	5.00	10	85.09



9.2 Active Mode Efficiency

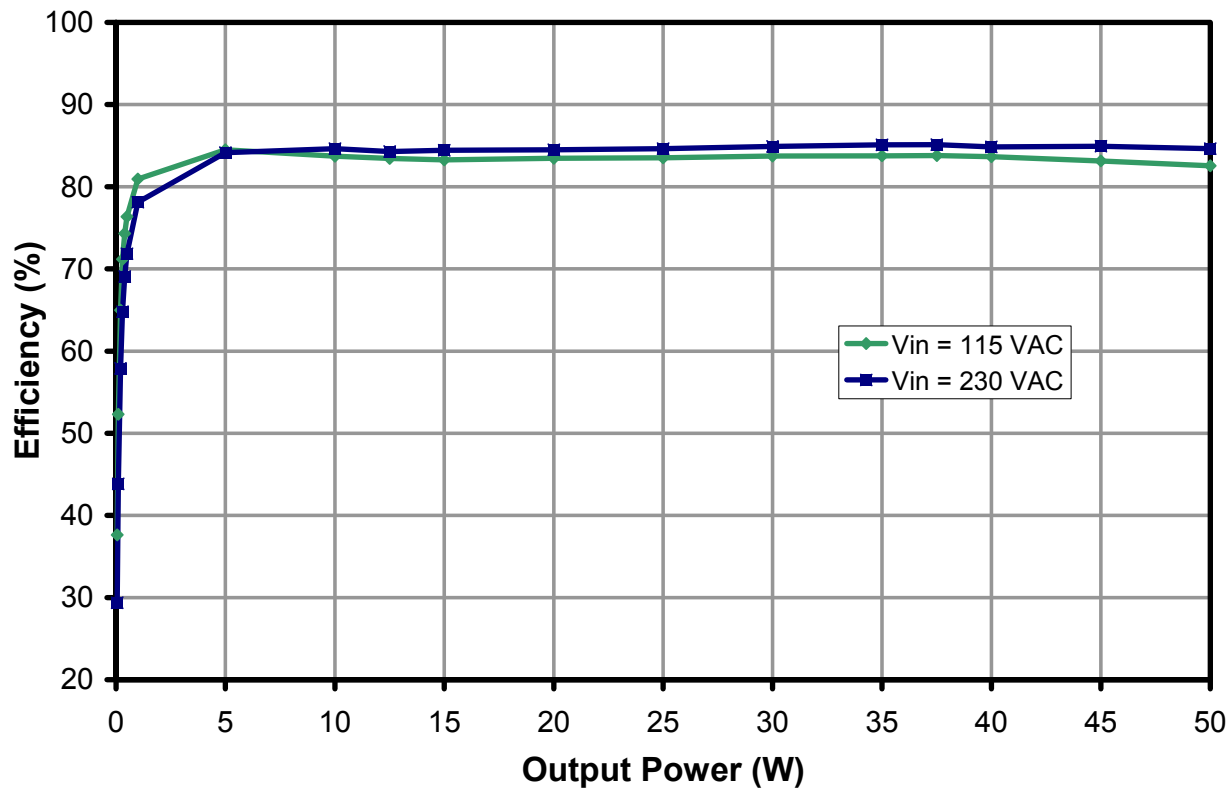

Figure 8 – Efficiency vs. Load.



9.3 Light Load Efficiency

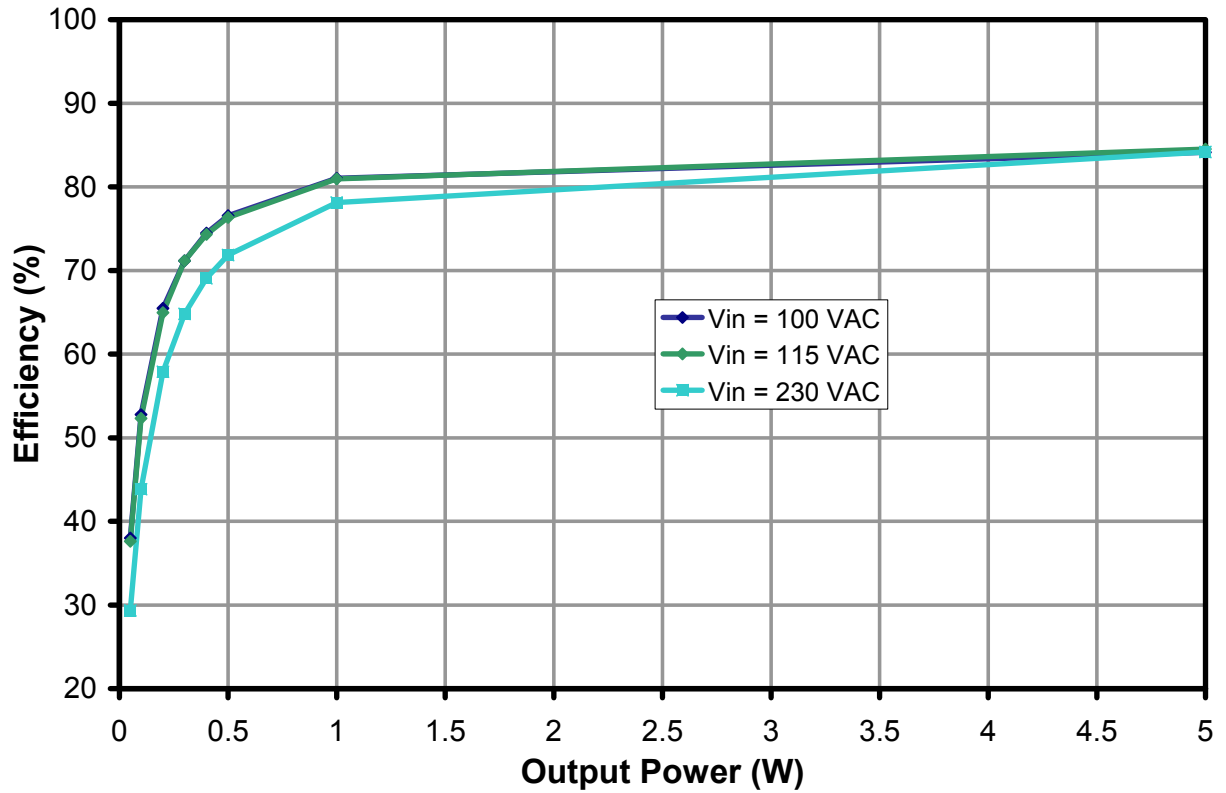

Figure 9 – Efficiency vs. Load.

AC-DC Light Load Efficiency Table			
P _{OUT} (W)	100 VAC	115 VAC	230 VAC
0.05	38.00%	37.61%	29.36%
0.1	52.77%	52.31%	43.84%
0.2	65.46%	64.97%	57.90%
0.3	71.15%	71.16%	64.80%
0.4	74.48%	74.32%	69.07%
0.5	76.57%	76.35%	71.85%
1	81.04%	80.95%	78.12%
5	84.13%	84.51%	84.16%



9.4 DC-DC Efficiency at 380 VDC Input

The DC-DC stage efficiency measurements were taken at light load to full load conditions at room temperature. 380 VDC was applied across the Bulk Capacitor C2 with RT1 removed.

9.4.1 Light Load Efficiency (380 VDC Input)

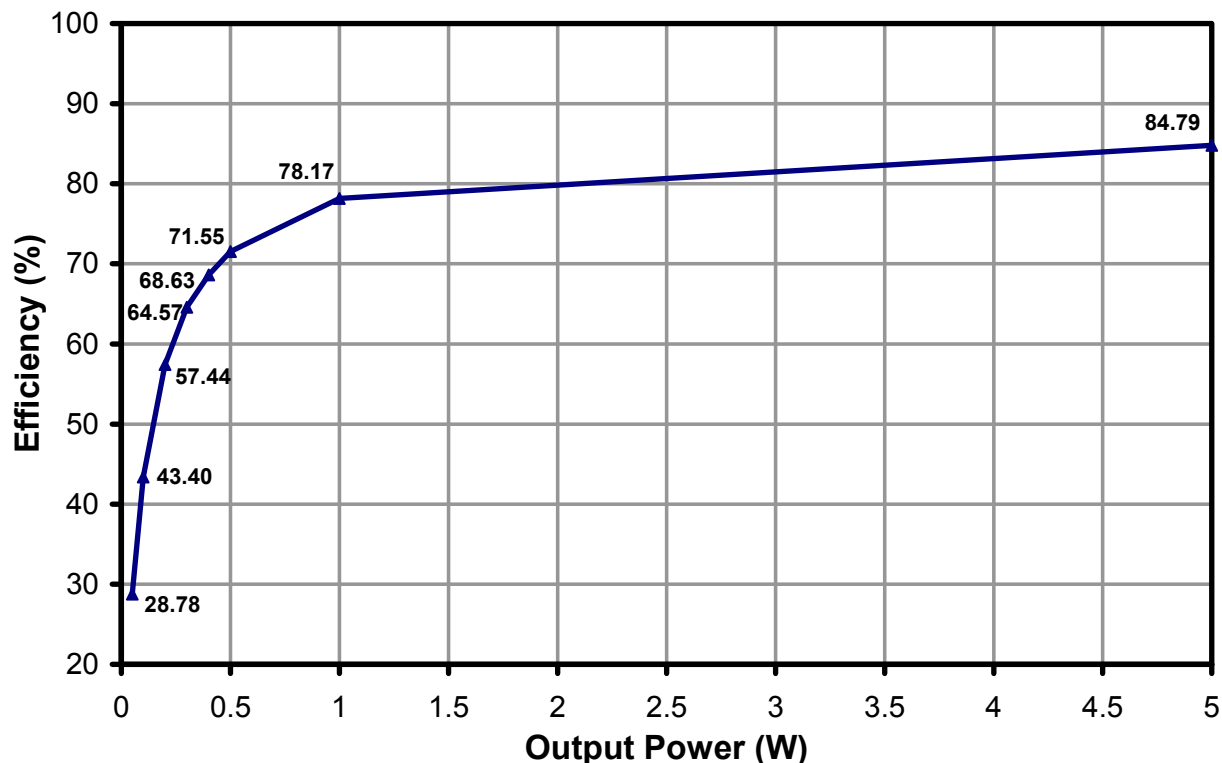

Figure 10 – DC-DC Efficiency vs. Load.

DC-DC Light Load Efficiency Table								
P _{OUT} (W)	0	0.1	0.2	0.3	0.4	0.5	1	5
Efficiency (%)	28.78	43.40	57.44	64.57	68.63	71.55	78.17	84.79



9.4.2 Active Mode Efficiency (380 VDC Input)

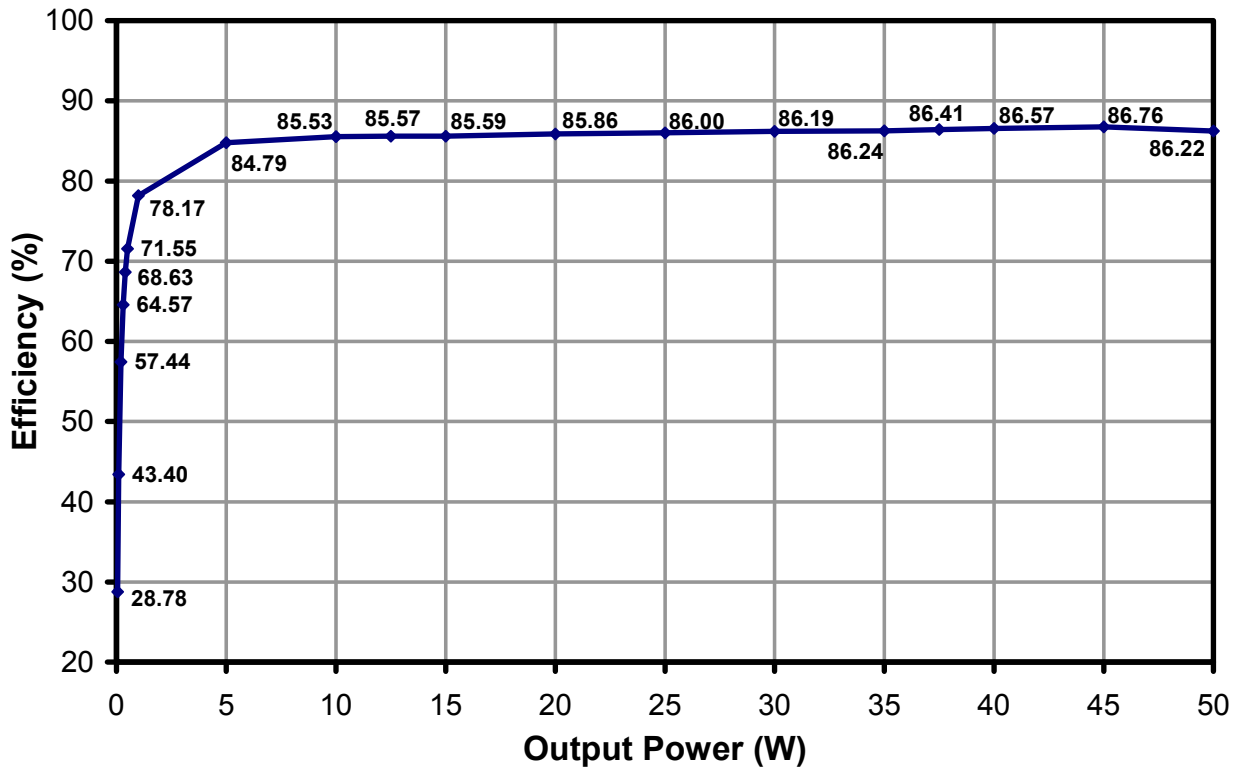

Figure 11 – DC-DC Efficiency vs. Load.



9.5 No-load Input Power

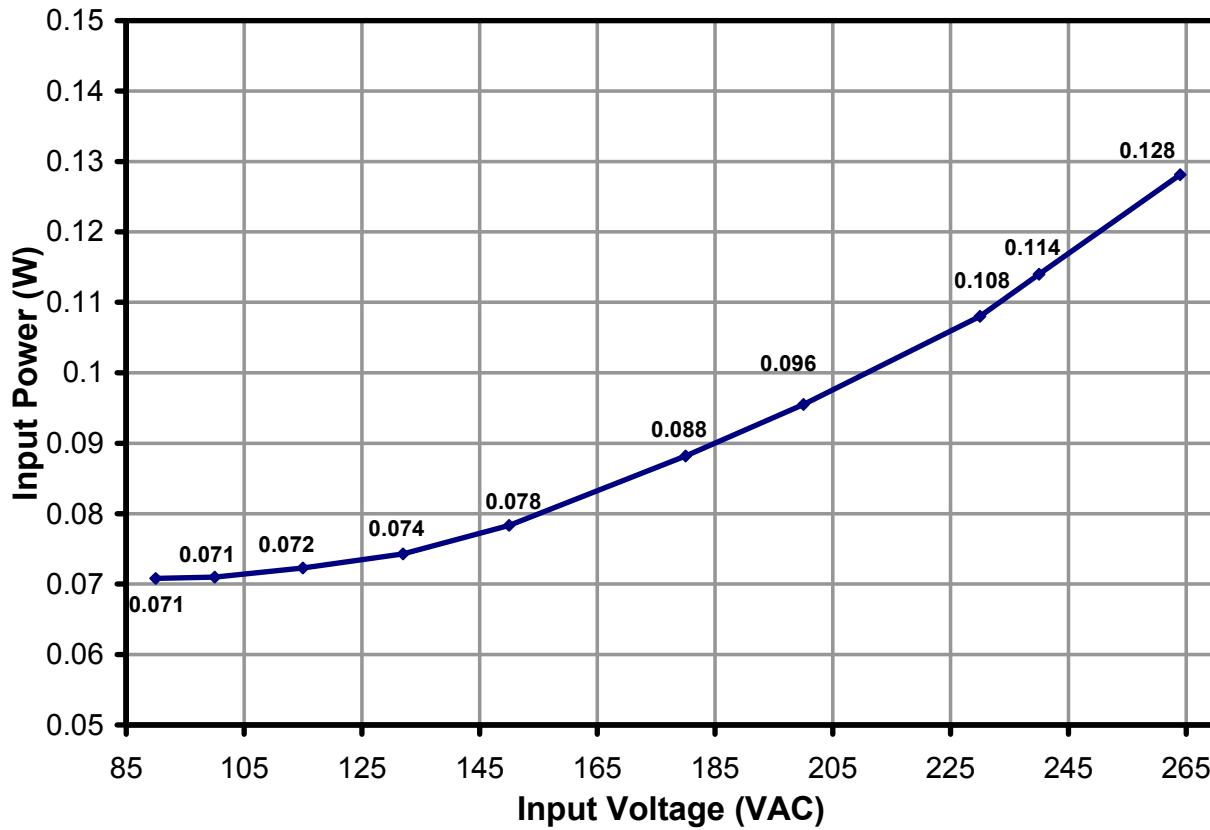

Figure 12 – Zero Load Input Power vs. Input Line Voltage, Room Temperature, 50 Hz.

Note: No-load input power can be optimized below <100 mW by reducing the bias supply for the C pin of U1 to 8 V.



9.6 Available Standby Output Power

The chart below shows the available output power vs line voltage for an input power of 1 W, 2 W and 3 W.

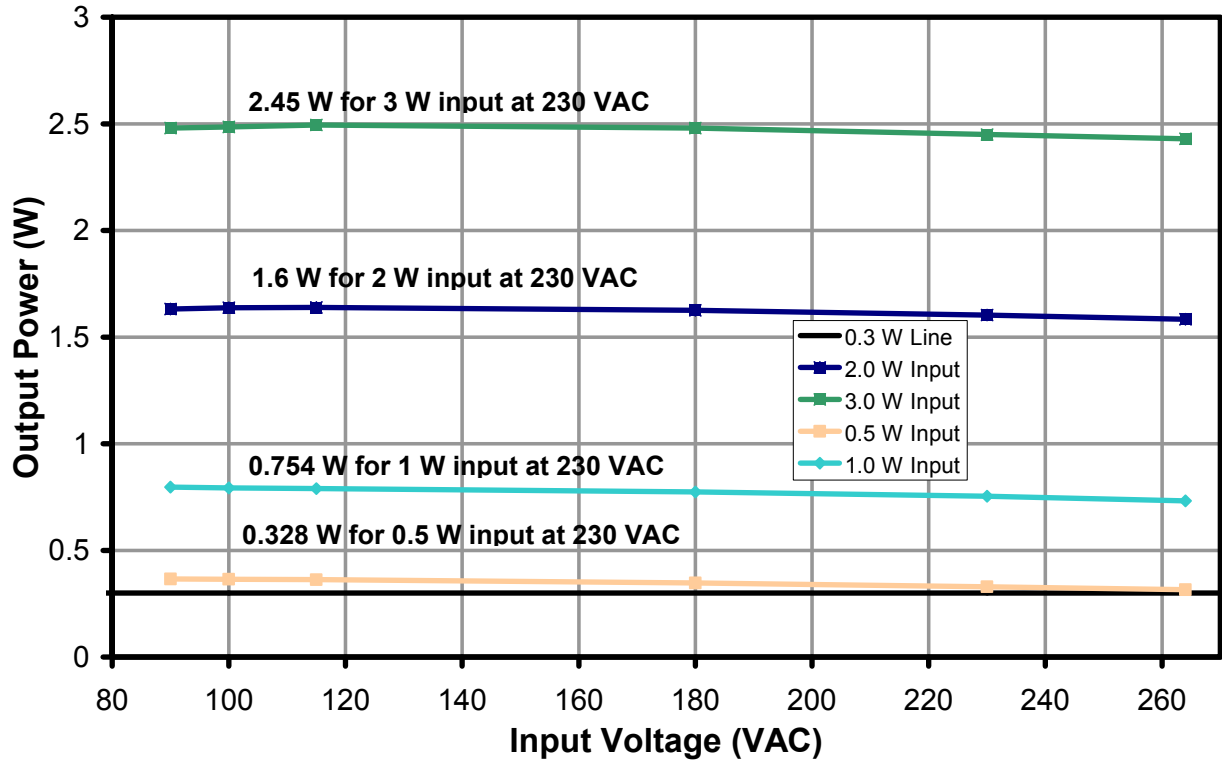

Figure 13 – Available Standby Output Power.

9.7 Regulation

9.7.1 Load

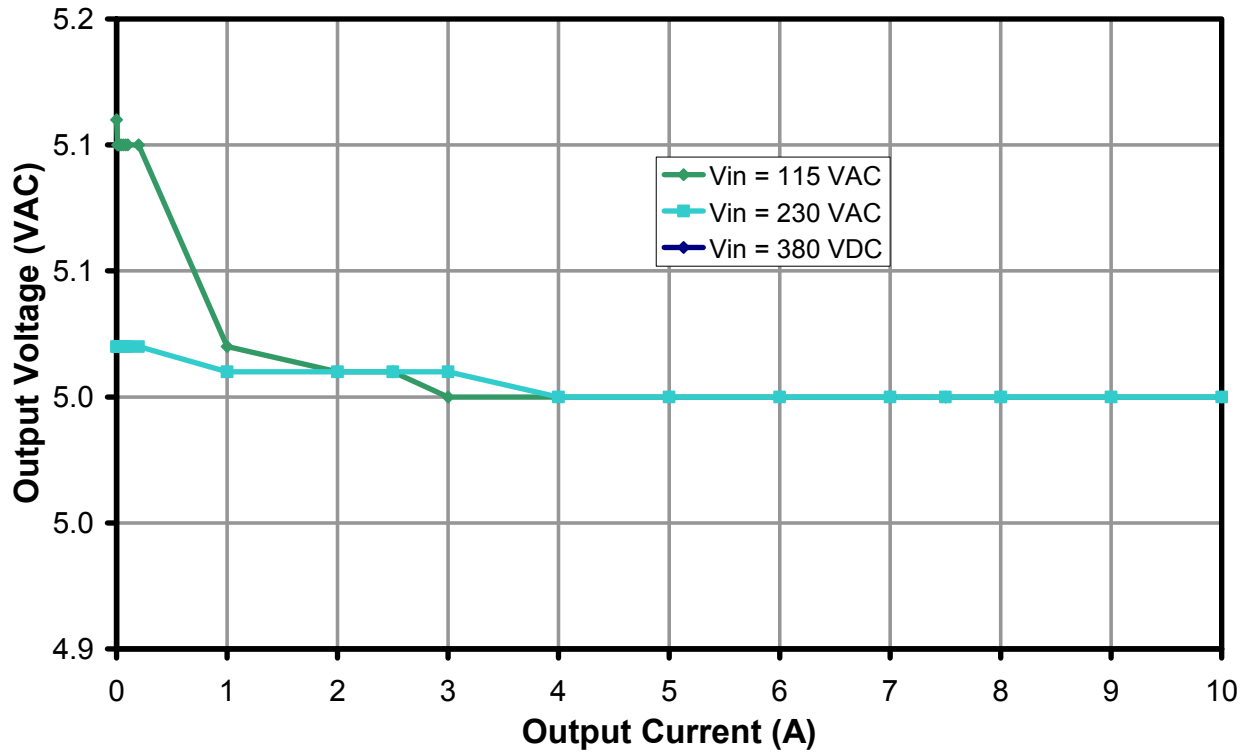

Figure 14 – Load Regulation, Room Temperature.



9.7.2 Line

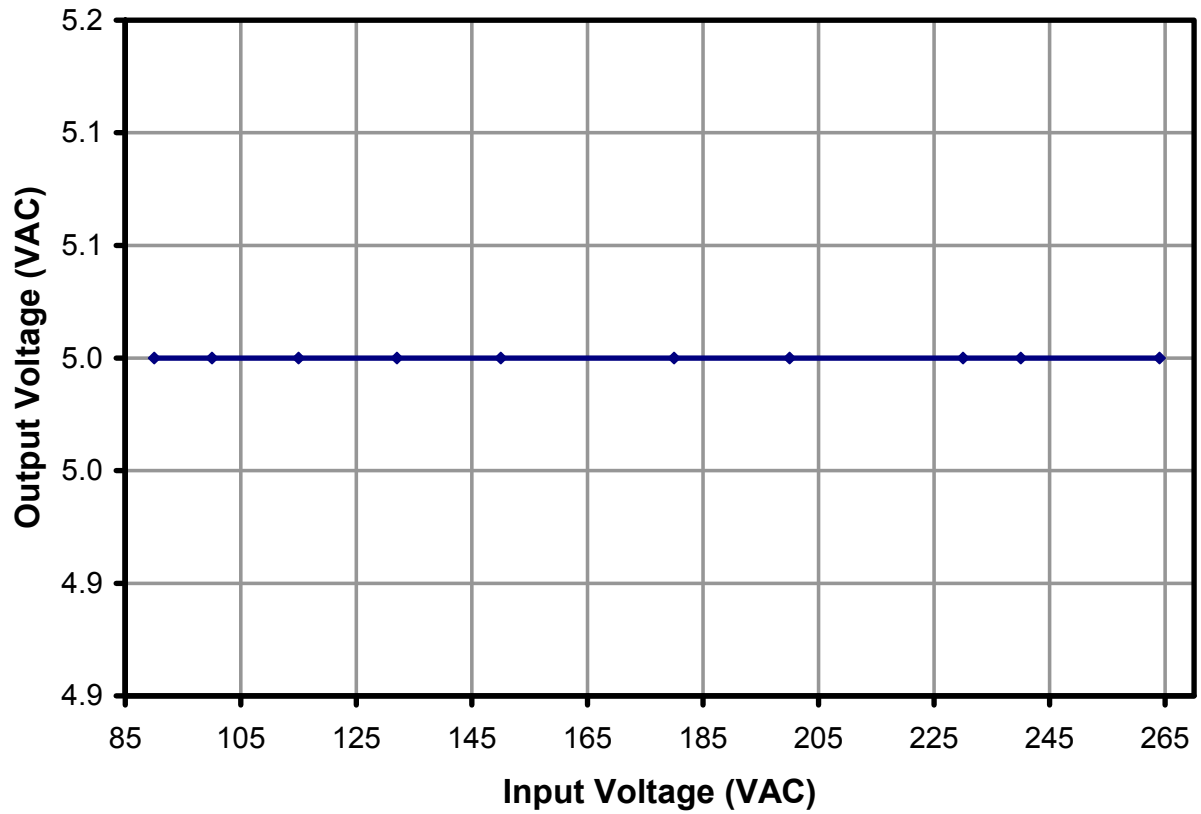

Figure 15 – Line Regulation, Room Temperature, Full Load.



10 Thermal Performance

The major semiconductors and output capacitors thermal data were taken using a thermal imaging camera. The power supply was tested at open frame, room temperature, and at 90 VAC, 50 Hz.

Notice that the temperature of U1 (TOP267EG) is relatively low. This indicates the size of the heat sink can be reduced for lower cost.

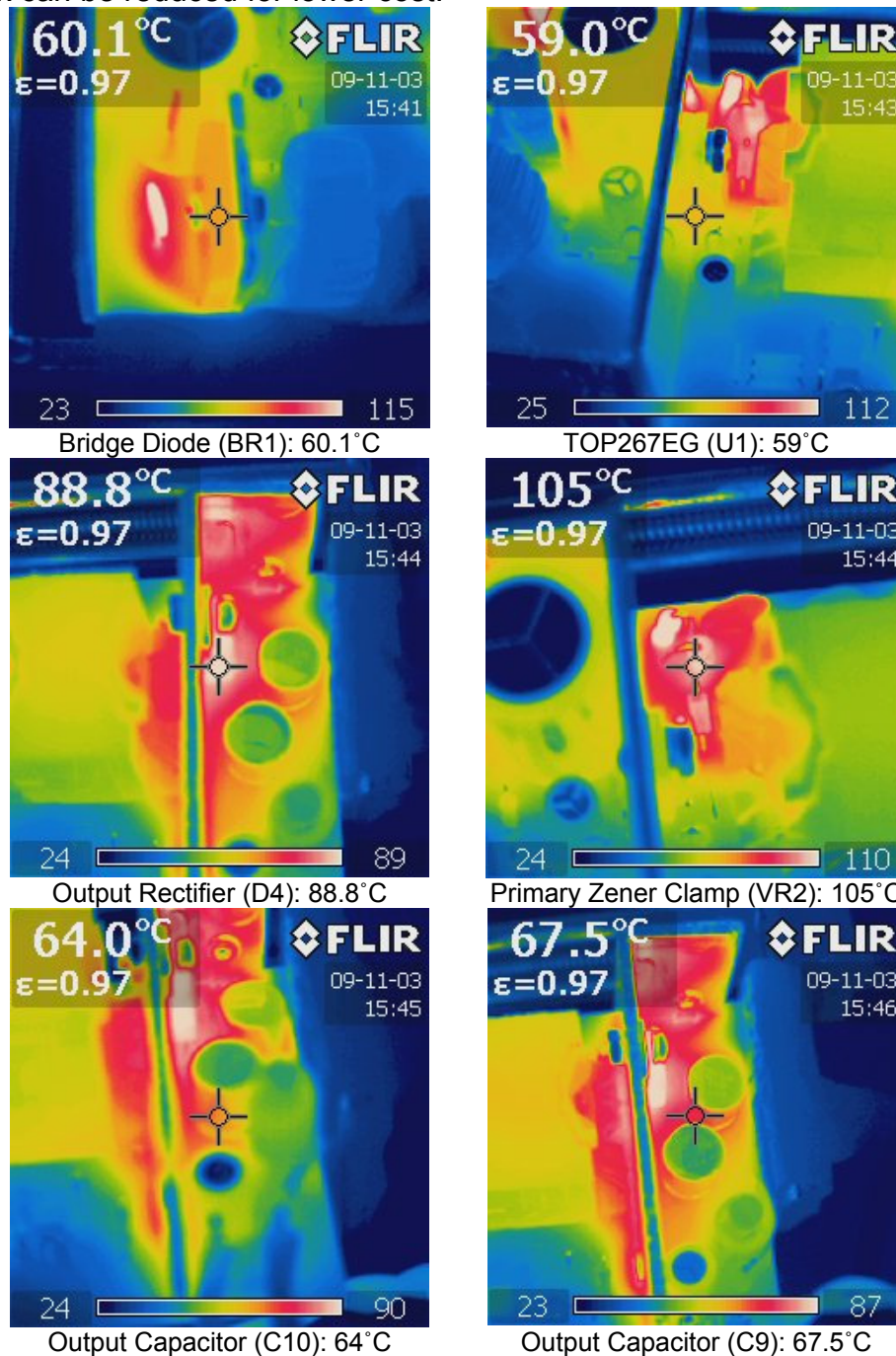

Figure 16 – Critical Components Thermal Scan.



11 Waveforms

11.1 Drain Voltage and Current, Normal Operation

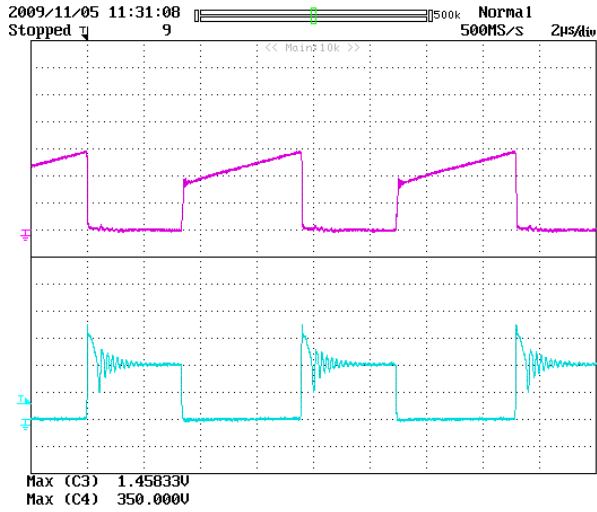

Figure 17 – 85 VAC, Full Load.
Upper: I_{DRAIN} , 0.5 A / div.
Lower: V_{DRAIN} , 100 V / div.

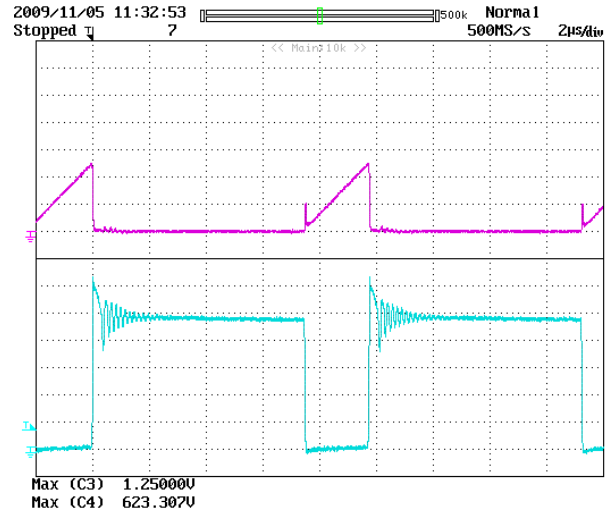

Figure 18 – 265 VAC, Full Load.
Upper: I_{DRAIN} , 0.5 A / div.
Lower: V_{DRAIN} , 100 V / div.

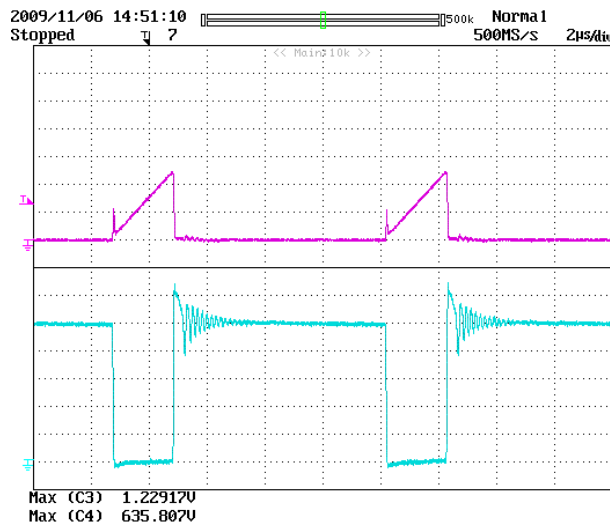

Figure 19 – 380 VDC, Full Load.
Upper: I_{DRAIN} , 0.5 A / div.
Lower: V_{DRAIN} , 100 V / div.



11.2 Output Voltage Start-up Profile

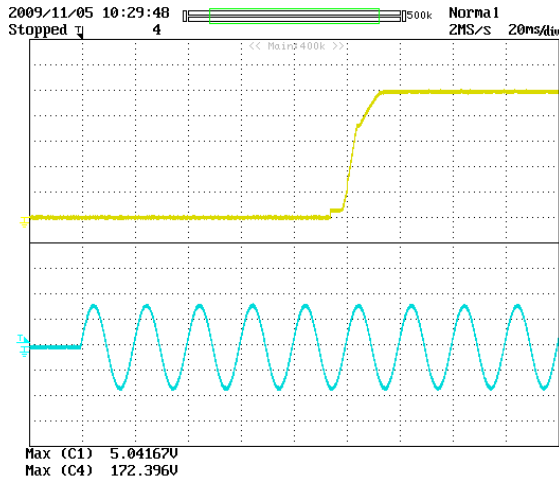

Figure 20 – 115 VAC, Full Load.
Upper: V_{OUT} , 1 V / div.
Lower: V_{IN} , 100 V / div.

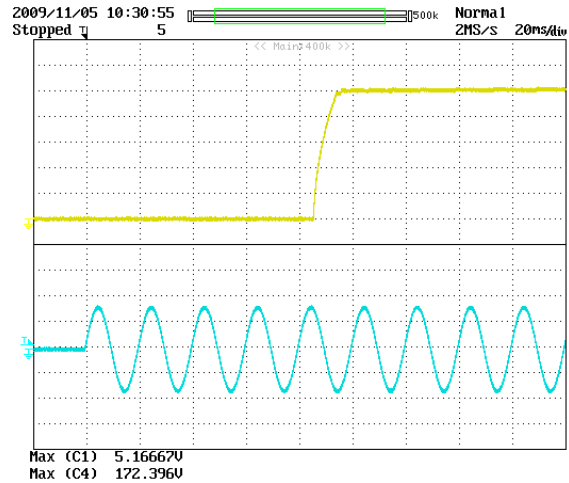

Figure 21 – 115 VAC, No-load.
Upper: V_{OUT} , 1 V / div.
Lower: V_{IN} , 100 V / div.

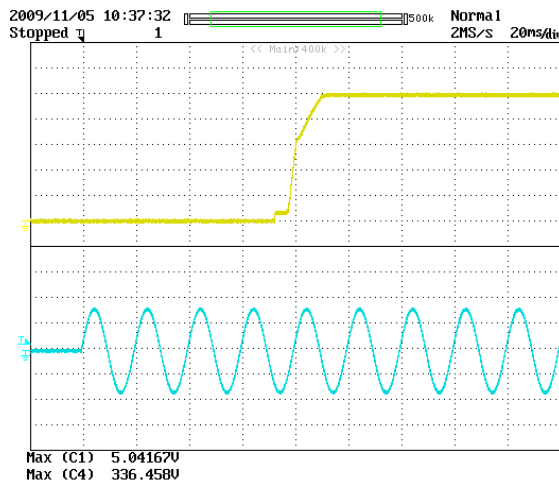

Figure 22 – 230 VAC, Full Load.
Upper: V_{OUT} , 1 V / div.
Lower: V_{IN} , 200 V / div.

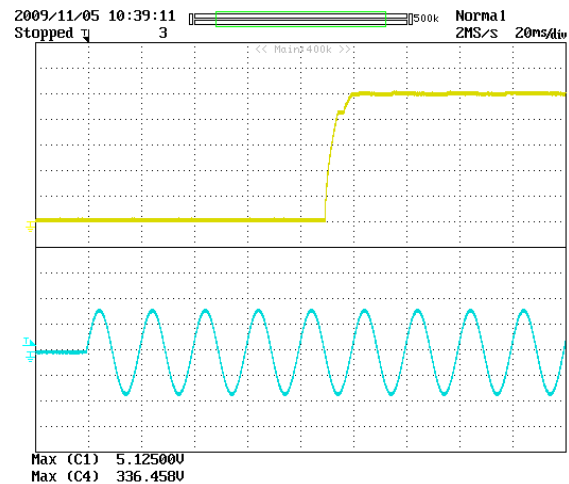

Figure 23 – 230 VAC, No-load.
Upper: V_{OUT} , 1 V / div.
Lower: V_{IN} , 200 V / div.



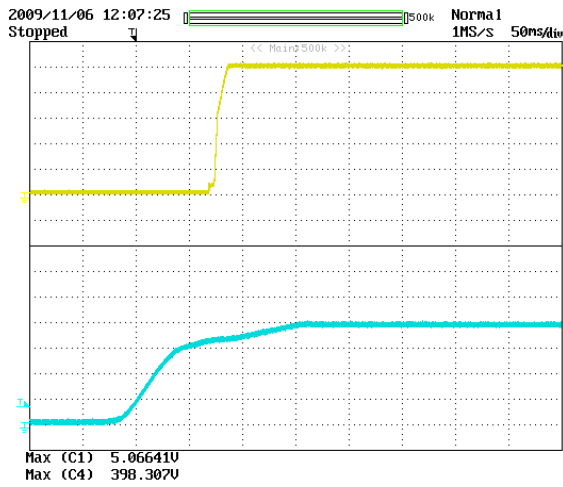

Figure 24 – 380 VDC, Full Load.
Upper: V_{OUT} , 1 V / div.
Lower: V_{IN} , 100 V / div.

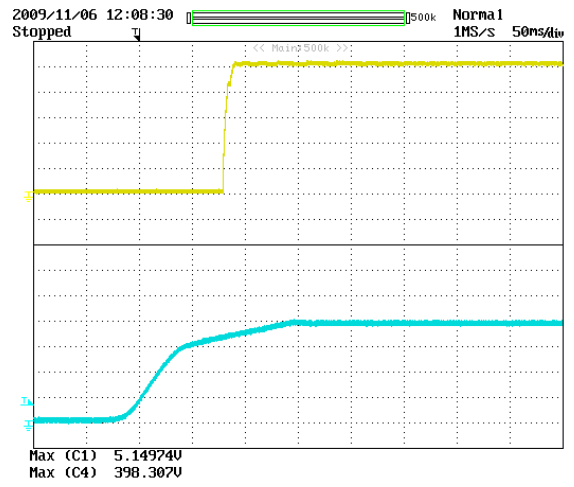

Figure 25 – 380 VDC, No Load.
Upper: V_{OUT} , 1 V / div.
Lower: V_{IN} , 100 V / div.



11.3 Drain Voltage and Current Start-up Profile

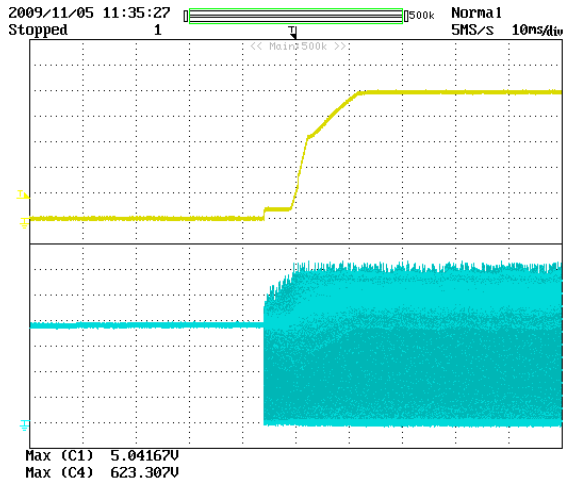

Figure 26 – 264 VAC, Full Load Start-up.
Upper: V_{OUT} , 1 V / div.
Lower: V_{DRAIN} , 100 V / div.

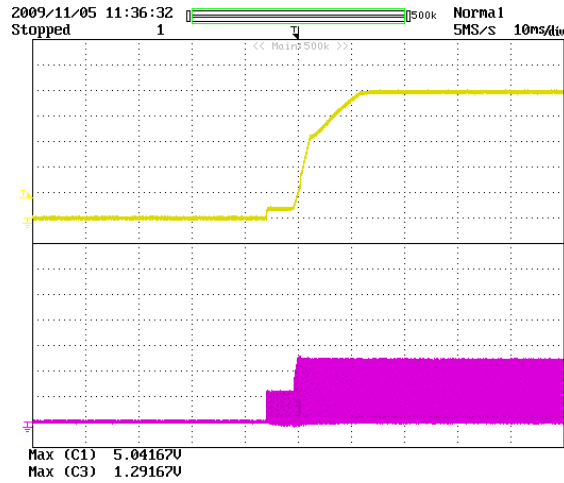

Figure 27 – 264 VAC, Full Load Start-up.
Upper: V_{OUT} , 1 V / div.
Lower: I_{DRAIN} , .5 A / div.

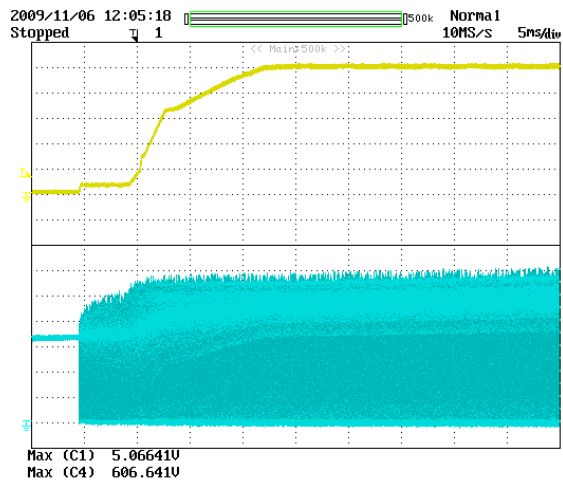

Figure 28 – 380 VDC, Full Load Start-up.
Upper: V_{OUT} , 1 V / div.
Lower: V_{DRAIN} , 100 V / div.

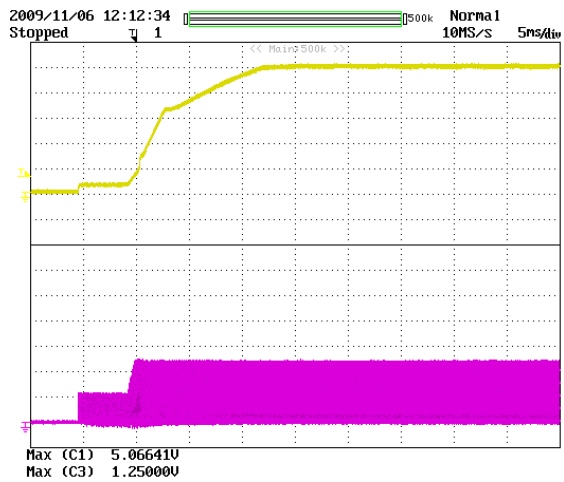

Figure 29 – 264 VAC, Full Load Start-up.
Upper: V_{OUT} , 1 V / div.
Lower: I_{DRAIN} , .5 A / div.



11.4 Load Transient Response

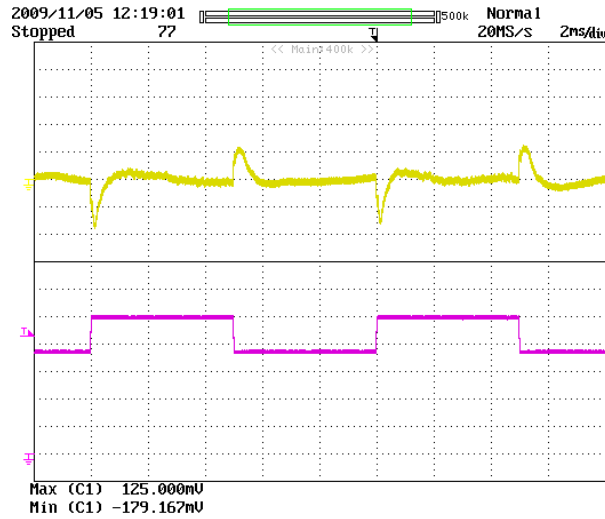

Figure 30 – 115 VAC, 50 Hz: 75% ↔ 100%.
Upper: V_{OUT} (AC COUPLED), 100 mV / div.
Lower: I_{OUT} , 2 A / div.

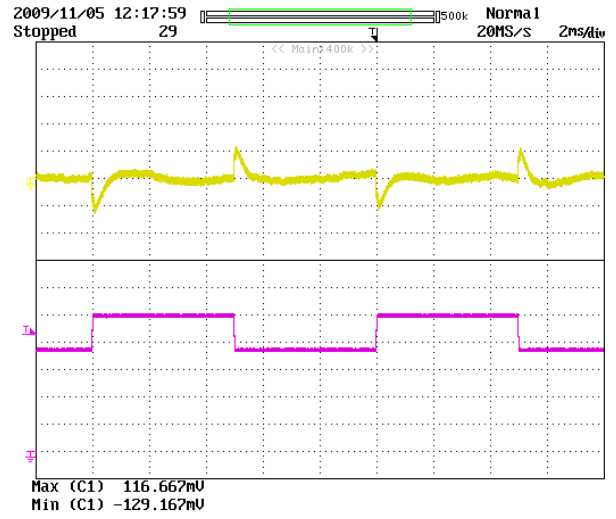

Figure 31 – 230 VAC, 50 Hz: 75% ↔ 100%.
Upper: V_{OUT} (AC COUPLED), 100 mV / div.
Lower: I_{OUT} , 2 A / div.

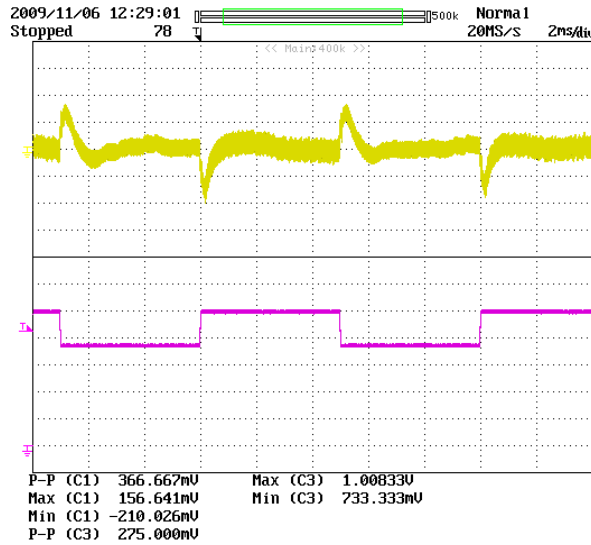

Figure 32 – 380 VDC, 50 Hz: 75% ↔ 100%.
Upper: V_{OUT} (AC COUPLED), 100 mV / div.
Lower: I_{OUT} , 2 A / div.



11.5 Output Ripple Measurements

11.5.1 Ripple Measurement Technique

For DC output ripple measurements, a modified oscilloscope test probe must be utilized in order to reduce spurious signals due to pickup. Details of the probe modification are provided in the figures below.

The 4987BA probe adapter is affixed with two capacitors tied in parallel across the probe tip. The capacitors include one (1) 0.1 μF /50 V ceramic type and one (1) 1.0 μF / 50 V aluminum electrolytic. The aluminum electrolytic type capacitor is polarized, so proper polarity across DC outputs must be maintained (see below).

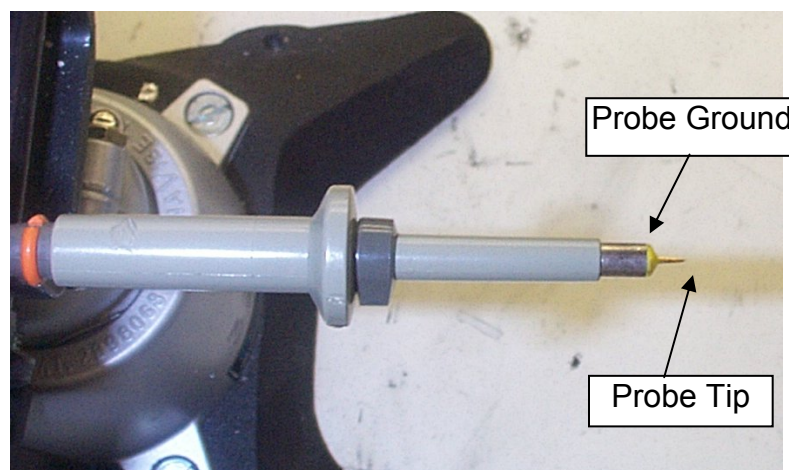

Figure 33 – Oscilloscope Probe Prepared for Ripple Measurement. (End Cap and Ground Lead Removed)

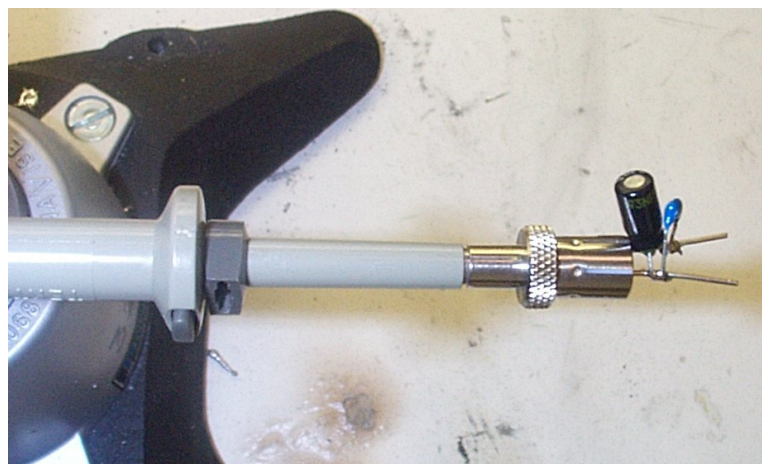

Figure 34 – Oscilloscope Probe with Probe Master (www.probemaster.com) 4987A BNC Adapter. (Modified with wires for ripple measurement, and two parallel decoupling capacitors added)



11.5.2 Measurement Results

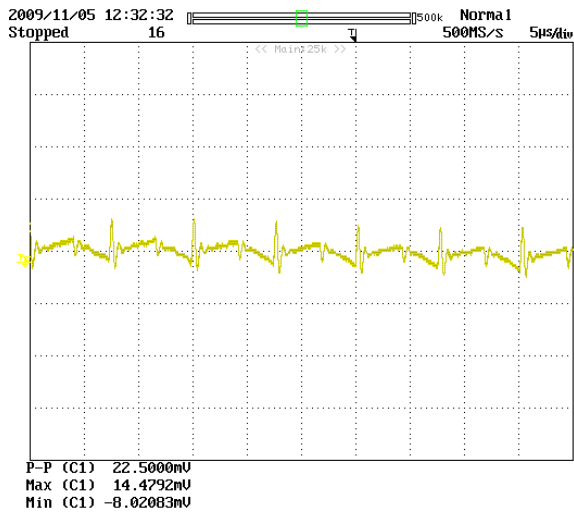

Figure 35 – 115 VAC: 5 μ s / div.

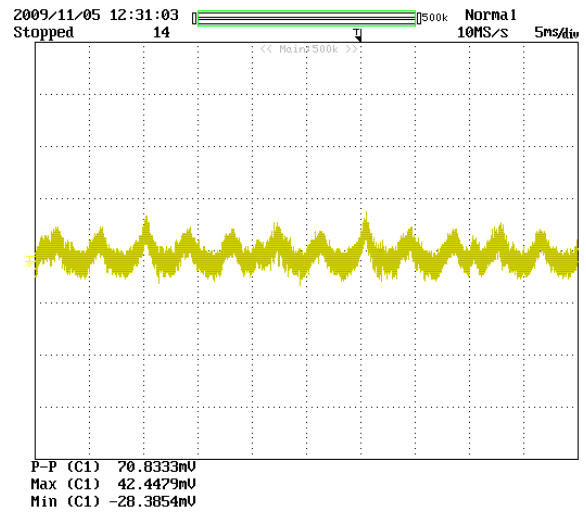

Figure 36 – 115 VAC: 5 ms / div.

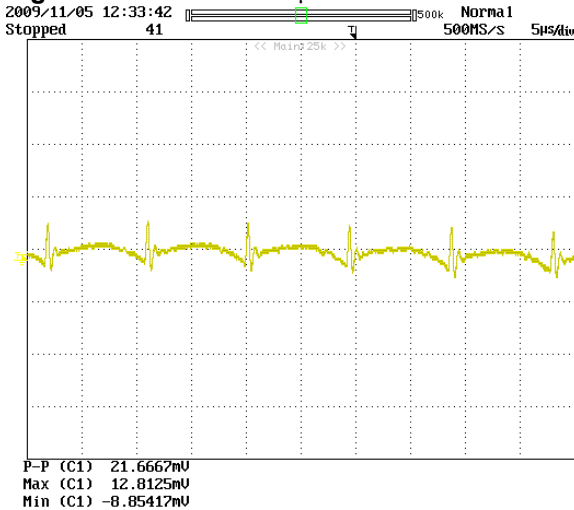

Figure 37 – 230 VAC: 5 μ s / div.

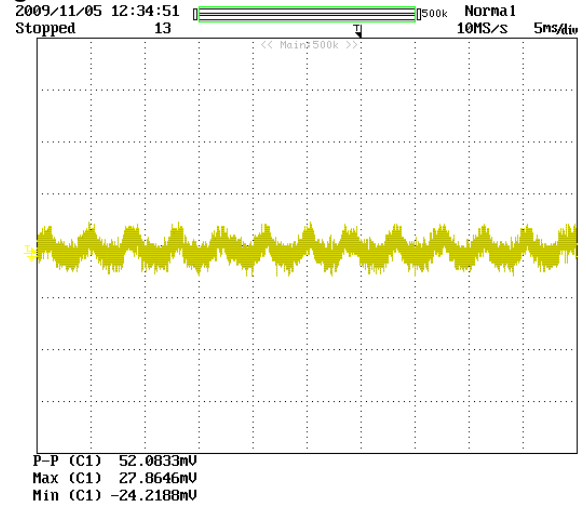

Figure 38 – 230 VAC: 5 ms / div.

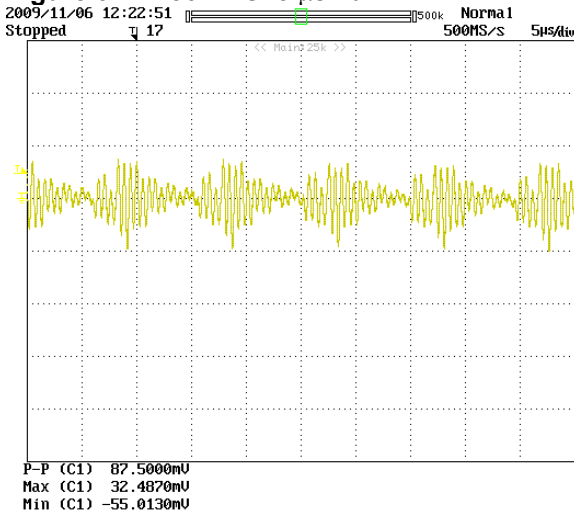

Figure 39 – 380 VDC: 5 μ s / div.

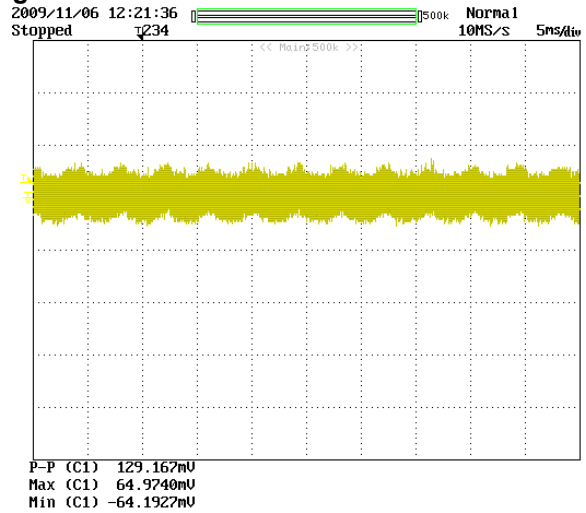

Figure 40 – 380 VDC: 5 ms / div.



12 Control Loop Measurements

12.1 115 VAC

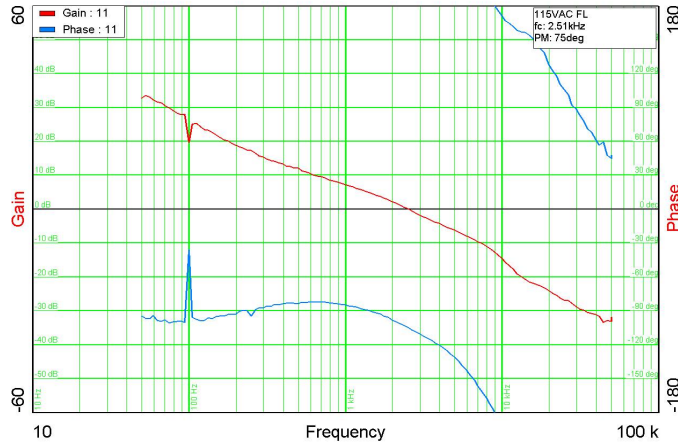

Figure 41 – Gain-Phase Plot, 115 VAC, Maximum Steady State Load.
 Vertical Scale: Gain = 10 dB / div., Phase = 30 ° / div.
 Crossover Frequency = **2.51 kHz**, Phase Margin = **75°**.

12.2 230 VAC

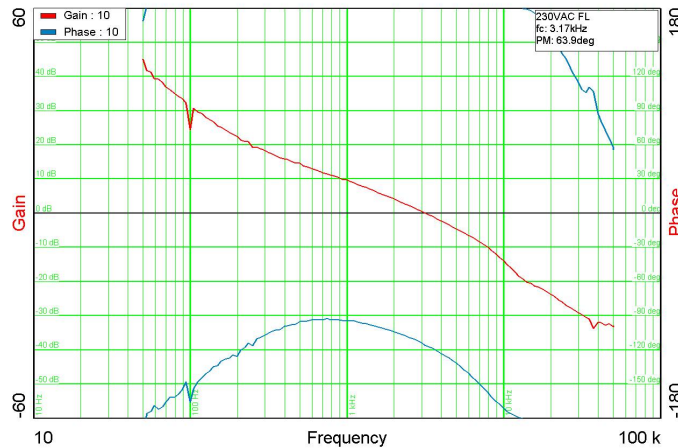

Figure 42 – Gain-Phase Plot, 230 VAC, Maximum Steady State Load.
 Vertical Scale: Gain = 10 dB / div., Phase = 30 ° / div.
 Crossover Frequency = **3.17 kHz**, Phase Margin = **63.9°**.



13 Revision History

Date	Author	Revision	Description & changes	Reviewed
17-Feb-10	CA	1.1	Initial Release	Apps & Mktg
09-Jul-12	KM	1.2	Updated Schematic	



For the latest updates, visit our website: www.powerint.com

Power Integrations reserves the right to make changes to its products at any time to improve reliability or manufacturability. Power Integrations does not assume any liability arising from the use of any device or circuit described herein. POWER INTEGRATIONS MAKES NO WARRANTY HEREIN AND SPECIFICALLY DISCLAIMS ALL WARRANTIES INCLUDING, WITHOUT LIMITATION, THE IMPLIED WARRANTIES OF MERCHANTABILITY, FITNESS FOR A PARTICULAR PURPOSE, AND NON-INFRINGEMENT OF THIRD PARTY RIGHTS.

PATENT INFORMATION

The products and applications illustrated herein (including transformer construction and circuits' external to the products) may be covered by one or more U.S. and foreign patents, or potentially by pending U.S. and foreign patent applications assigned to Power Integrations. A complete list of Power Integrations' patents may be found at www.powerint.com. Power Integrations grants its customers a license under certain patent rights as set forth at <http://www.powerint.com/ip.htm>.

The PI Logo, TOPSwitch, TinySwitch, LinkSwitch, DPA-Switch, PeakSwitch, CAPZero, SENZero, LinkZero, HiperPFS, HiperTFS, HiperLCS, Qspeed, EcoSmart, Clampless, E-Shield, Filterfuse, StackFET, PI Expert and PI FACTS are trademarks of Power Integrations, Inc. Other trademarks are property of their respective companies. ©Copyright 2012 Power Integrations, Inc.

Power Integrations Worldwide Sales Support Locations**WORLD HEADQUARTERS**

5245 Hellyer Avenue
San Jose, CA 95138, USA.
Main: +1-408-414-9200
Customer Service:
Phone: +1-408-414-9665
Fax: +1-408-414-9765
e-mail: usasales@powerint.com

GERMANY

Lindwurmstrasse 114
80337, Munich
Germany
Phone: +49-895-527-39110
Fax: +49-895-527-39200
e-mail: eurosales@powerint.com

JAPAN

Kosei Dai-3 Building
2-12-11, Shin-Yokohama,
Kohoku-ku, Yokohama-shi,
Kanagawa 222-0033
Japan
Phone: +81-45-471-1021
Fax: +81-45-471-3717
e-mail: japansales@powerint.com

TAIWAN

5F, No. 318, Nei Hu Rd.,
Sec. 1
Nei Hu District
Taipei 114, Taiwan R.O.C.
Phone: +886-2-2659-4570
Fax: +886-2-2659-4550
e-mail: taiwansales@powerint.com

CHINA (SHANGHAI)

Rm 1601/1610, Tower 1
Kerry Everbright City
No. 218 Tianmu Road West
Shanghai, P.R.C. 200070
Phone: +86-021-6354-6323
Fax: +86-021-6354-6325
e-mail: chinasales@powerint.com

INDIA

#1, 14th Main Road
Vasanthanagar
Bangalore-560052
India
Phone: +91-80-4113-8020
Fax: +91-80-4113-8023
e-mail: indiasales@powerint.com

KOREA

RM 602, 6FL
Korea City Air Terminal B/D,
159-6
Samsung-Dong, Kangnam-Gu,
Seoul, 135-728 Korea
Phone: +82-2-2016-6610
Fax: +82-2-2016-6630
e-mail: koreasales@powerint.com

EUROPE HQ

1st Floor, St. James's House
East Street, Farnham
Surrey GU9 7TJ
United Kingdom
Phone: +44 (0) 1252-730-141
Fax: +44 (0) 1252-727-689
e-mail: eurosales@powerint.com

CHINA (SHENZHEN)

3rd Floor, Block A, Zhongtuo
International Business Center, No.
1061, Xiang Mei Road, FuTian District,
ShenZhen, China, 518040
Phone: +86-755-8379-3243
Fax: +86-755-8379-5828
e-mail: chinasales@powerint.com

ITALY

Via Milanese 20, 3rd Fl.
20099 Sesto San Giovanni
(MI) Italy
Phone: +39-024-550-8701
Fax: +39-028-928-6009
e-mail: eurosales@powerint.com

SINGAPORE

51 Newton Road,
#19-01/05 Goldhill Plaza
Singapore, 308900
Phone: +65-6358-2160
Fax: +65-6358-2015
e-mail: singaporesales@powerint.com

APPLICATIONS HOTLINE

World Wide +1-408-414-9660

APPLICATIONS FAX

World Wide +1-408-414-9760

